



---

---

# OPERATION MANUAL

---

PRODUCT NAME : **Multi-counter**

MODEL : **CEU5**

● READ THIS OPERATION MANUAL CAREFULLY BEFORE USE IT.

● NEVER INSTALL THE PRODUCT UNTIL FINISH READING THIS

● KEEP THIS MANUAL ALL THE TIME FOR YOUR REFERENCE.



**SMC CORPORATION**

# Contents

Chapter 1: Read Before Use	1
Chapter 2: Product Summary	4
2-1. How to Order	4
2-2. Outside Dimensions	4
Chapter 3: Functions and Terminology	5
Chapter 4: Specifications	8
Chapter 5: Description of Each Part	10
Chapter 6: Wiring	
6-1. Terminal block arrangement	11
6-2. Wiring of sensor input part	11
6-3. Wiring of control signal input part	12
6-4. Wiring of output part	12
6-5. Wiring of RS-232C	12
6-6. Noise countermeasures	13
Chapter 7: Setting and Counter operation	
7-1. Modes and setting items	14
7-1-1. Mode types and functions	14
7-1-2. Mode switching procedure	14
7-1-3. Setting of function mode	15
7-1-4. Data setting range	16
7-2. Setting	17
7-3. Counter operation	21
7-3-1. Handling data range	21
7-3-2. Reset and hold input	21
7-3-3. Correspondence of banks and bank terminals at switching	21
7-3-4. Correspondence of preset numbers and output terminals	21
7-3-5. Output	22
7-3-6. Preset output forms list	23
7-3-7. Output timing chart	24
7-4. Memory (E <sup>2</sup> ROM)	26
Chapter 8: RS-232C Communication Functions	
8-1. Communication specifications	27
8-2. Communication format	27
Chapter 9: BCD Output	39
Chapter 10: When the counter does not operate normally	
10-1. Troubleshooting	41
10-2. Counter error indication	43

## Chapter 1: Read Before Use

These safety instructions are intended to prevent a hazardous situation and/ or equipment damage. These instructions indicate the level of potential hazard by label of “Caution”, “Warning” or “Danger”. To ensure safety, follow the below instructions as well as other safety instructions.

 <b>Caution</b>	Operator error could result in injury or equipment damage.
 <b>Warning</b>	Operator error could result in serious injury or loss of life.
 <b>Danger</b>	In extreme conditions, there is a possible result of serious injury or loss of life.

 <b>Warning</b>
--

1. The compatibility of pneumatic equipment is the responsibility of the person who designs the pneumatic system or decides its specifications.

Since the products specified here are used in various operating conditions, their compatibility for the specific pneumatic system must be based on specifications or after analysis and/ or tests to meet your specific requirements. Ensuring the initial performance and safety are the responsibility of the person who decides the compatibility of pneumatic system. Pneumatic systems should be constructed after full review on the details of the products other than specifications and possibilities of failures by checking the latest product information.

2. Only trained personnel should operate pneumatically operated machinery and equipment.

Assembly, handling or repair of pneumatic systems should be performed by trained and experienced operators.

3. Do not service machinery/ equipment or attempt to remove component until safety is confirmed.

- a. Inspection and maintenance of machinery/ equipment should only be performed after confirmation of safe locked-out control positions.
- b. When equipment is to be removed, confirm the safety process as mentioned above. Cut the supply pressure for this equipment and exhaust all residual compressed air in the system.
- c. Before machinery/ equipment is re-started, take measures to prevent shooting-out of cylinder piston rod etc.

4. Contact SMC and take necessary safety measures if the products are to be used in any of the following conditions:

- a. Conditions and environments beyond the given specifications, or if products are used outdoors.
- b. Installation on equipment in conjunction with atomic energy, railway, air navigation, vehicles, medical equipment, food and beverage, recreation equipment, emergency stop circuits, press applications, or safety equipment.
- c. An application which has the possibility of having negative effects on people, property, or animals, requiring special safety analysis.

## Installation

### **Warning**

1. Operation manual

Do not install the products unless the safety instructions have been read and understood.  
Keep this operation manual on file for future reference.

### **Caution**

1. Maintenance space

When installing the products, allow space for maintenance.

## Wiring

### **Warning**

1. Preparation for wiring

Shut off the power before wiring (including insertion and removal of connectors). Mount a protective cover on the terminal block after wiring.

2. Check the power

Make sure the power has sufficient capacity and voltages are within the specified range before wiring.

3. Grounding

Ground terminal block F.G. (Frame Ground). Do not ground it with devices generating strong electromagnetic noise.

4. Separation of signal wires from power wire

Avoid common or parallel wiring of signal and power wires to prevent malfunction due to noise.

5. Check wiring

Incorrect wiring may cause damage or malfunction of the products. Make sure the wiring is correct before operation.

6. Wiring arrangement and fixation

Avoid bending cables sharply at connector part or electrical entry in wiring arrangement.

Inproper arrangement may cause disconnection which in turn causes malfunction. Fix cables close enough not to give excessive force to the connector.

## Operating and Storage Environments

### **Warning**

1. Environments to avoid

Avoid using or storing the products in the following environments which may cause failures.  
If the products need to be used or stored in those environments, take necessary measures.

- a. Place where ambient temperature exceeds the range of 0°C to 50°C.
- b. Place where ambient humidity exceeds the range of 35% to 85% RH.
- c. Place where condensation occurs due to sudden temperature change.
- d. Place where atmosphere containing corrosive gas, flammable gas or organic solvent.
- e. Place where atmosphere containing conductive powder such as dust and iron chips, oil mist, salt, or organic solvent, or splashing cutting chips, dust and cutting oil (water , liquid) over the products.
- f. Place where the products are exposed to direct sunlight or radiated heat.
- g. Place where strong electromagnetic noise is generated (place where strong electric field, strong magnetic field or surge is generated).
- h. Place where static electricity is discharged or condition that the products have electrostatic discharge.
- i. Place where strong high frequency is generated.
- j. Place where damages of thunder are expected.
- k. Place where vibration or impact is directly given to the products.
- l. Condition that the products are deformed by force or weight applied.

## Operation

### **Warning**

1. Terminal block protective cover

Key operation should be done with the condition that the terminal block protective cover is mounted. If human body touches the terminal block accidentally, an electric shock may be a result.

2. Prohibition of operation with wet hands

Do not perform key operation with wet hands, which may cause an electric shock and/ or failure of the products and other devices.

## Maintenance and Check

### **Caution**

1. Performing regular check

Check regularly that the products do not operate with failures unsolved. Check should be done by trained and experienced operators.

2. Prohibition of disassembly and modification

To prevent accidents such as failures and electric shocks, do not remove the cover to perform disassembly or modification. If the cover has to be removed, shut off the power before removal.

3. Disposal

Request a special agent for handling industrial waste to dispose the products.

## Chapter 2: Product Summary

This counter counts pulses coming from encoder (A/B quadrature pulse or UP/ DOWN individual pulse) and sends a signal to PC/ PLC if the count matches with the preset data. The method specified in the RS-232C allows this counter to send counts to PC/ PLC and set the counter by communications with PLC/ PC. For the counter with BCD output, counts can be sent to PC/ PLC by BCD coding.

### 2-1. How to Order

Eight variations of CEU5 are available for different functions.

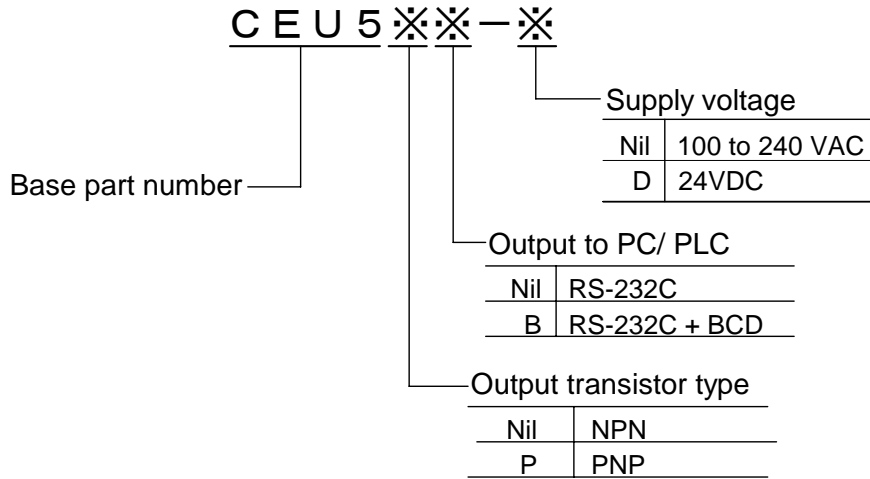

### 2-2. Outside Dimensions

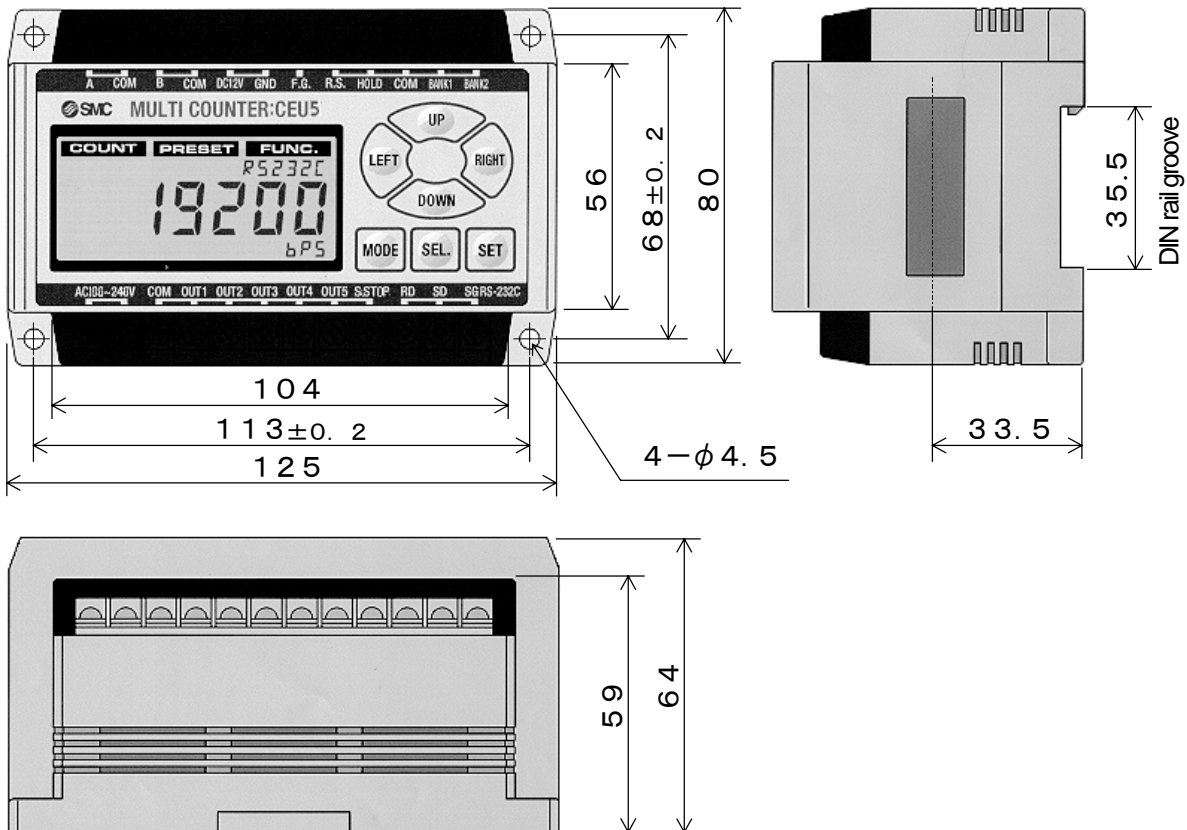

### Chapter 3: Functions and Terminology

Terms on output are defined as follows in this operation manual.

- Output signals

Output signals are signals from CEU5 to PLC/ PC: preset output, Cylinder stop output and BCD output.

Preset output	This is the output signal sent to PLC/ PC when counts are matched with the set values. Upper and lower limits can be set in preset output. Output form can be selected from three types.
Cylinder stop output	This is the output signal sent to PLC/ PC when pulses coming from encoder do not change for a certain time. This output signal provides better timing for reading preset output and outputs sent to PLC/ PC.
BCD output	This is the output signal of a value indicated on CEU 5 sent to PLC/ PC for 64ms.

- Preset output forms

Preset output forms are three types of output in preset output: compare, 1-shot and hold. Refer to “Preset output forms list” in a following page for details.

- Output method

Preset output can be selected from two methods: normal output and binary output. No. 1 through No. 31 can be stored in preset setting. However, No. 21 through No. 31 can be used only for binary output.

	Normal output	Binary output
Features	<ul style="list-style-type: none"> <li>· Allocate one output terminal to one preset number.</li> <li>· Divide preset numbers of 1 through 20 into four blocks, which are called bank 1 through 4 respectively.</li> <li>· Preset output is active for a preset number of a bank selected.</li> <li>· Bank can be switched by external signals.</li> </ul>	<ul style="list-style-type: none"> <li>· Send signals to PLC/ PC to indicate preset numbers matched with counts by using all the five output terminals.</li> <li>· To obtain information on preset output, output terminals 1 through 5 need to be checked.</li> <li>· This output is active only when cylinder stopped. Passed points are not outputted.</li> </ul>
Memory	20 presets(with bank function used)	31 presets
Application	<ul style="list-style-type: none"> <li>· 20 types of work can be sorted to Good or No Good when the types of work are known in advance.</li> <li>· Another equipment can be operated in the timing of preset output in CEU5.</li> <li>· This output can be used for switching preset output for work group or process.</li> </ul>	<ul style="list-style-type: none"> <li>· 31 types of work can be classified without external switching.</li> <li>· Unknown work types transferred can be classified into a maximum of 31 types.</li> </ul>

**CEU5 has the following features.**

(1) Multiplication function

All the pulses are multiplied by four times multiplier in hardware at input of A/B quadrature while it is multiplied by two times multiplier or no multiplier in software. This will provide higher resolution of measurement and improve the accuracy of the origin. The following figure shows the relation between count by four times multiplier and no multiplier.

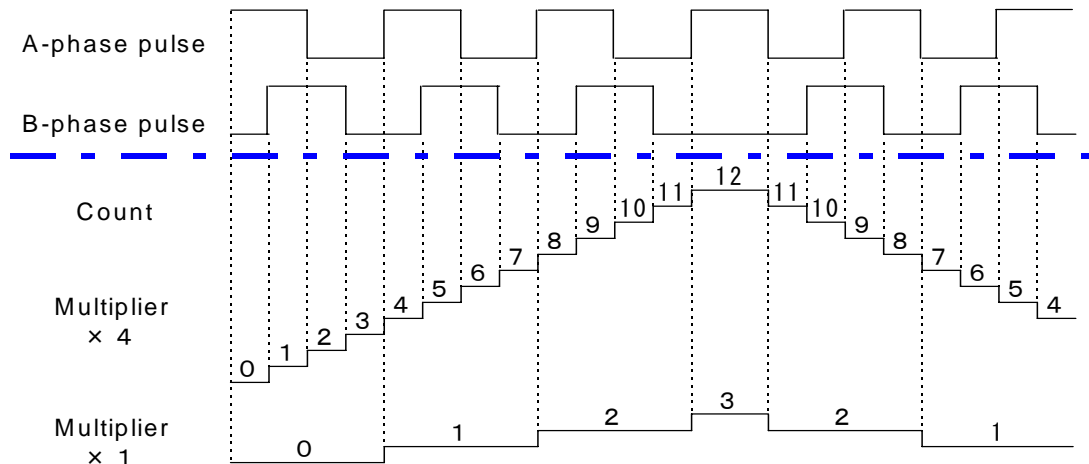

- \* Multiplier x 1 : Use quadrature input signals for a bi-directional count.
- \* Multiplier x 4 : Use quadrature input signals to count on leading and trailing edges of "A" and "B" for a bi-directional count.

(2) Switching of A/B quadrature input and UP/ DOWN individual pulse input

Accommodate to encoders with A/B quadrature output and UP/ DOWN individual pulse output.

(3) Pre-scale function

Function for the user to optionally set the number indicated for one count.

(4) Setting of tolerances for preset values

Upper and lower limits can individually set to preset values. Each set value can be either positive or negative. For example, tolerances of + 0.04 and + 0.01 can be inputted as in the tolerance indications in drawings.

(5) Bank functions (4 channels)

Preset output can be sent from 5 points simultaneously. Preset values of 5 points are grouped into one frame (bank) and there are four banks from 1 to 4. A maximum of 20 types of work can be classified by switching these banks. Refer to "Correspondence of bank and bank terminals at switching" in a following page.

(6) Binary output (31 points)

Preset output can be sent from 31 points without bank switching by sending signals from five output terminals in binary output method (If output signals are overlapped, a signal of smaller preset No. is sent. Output form is compare output only).



(7) Cylinder stop output

Cylinder stop output is a signal sent out from S. STOP terminal when pulse signals from encoder do not change for a certain period of time. This output signal provides better timing for reading preset output and outputs sent to PLC/ PC.

(8) Hold function (for RS-232C communication or BCD output)

The display on the counter is held during a hold signal is coming in. With RS-232C communication or BCD output, the data indicated is sent out. Even if reading process of the PLC is delayed, the count when the hold signal is inputted can be taken in (The display is held, however, counting is continued inside. At this time, preset output is sent out according to the count inside with or without hold signal).

(9) Backing up of counts (changeable between hold and non-hold)

Back up counts after power interruptions. This function can be selected either ON or OFF.

(10) RS-232C communication function

Count output and setting of each function can be done by PLC (with RS-232C functions) or PC in serial transmission of the RS-232C specifications.

(11) BCD output function (equipped only with CEU5\*B-\* type)

Send out counts by BCD coding. This function also allows taking in counts by PLC or PC and connecting to external large indicator.

## Chapter 4: Specifications

Product	Multi-counter
Mounting	Surface mount (with DIN rail or set screws)
Operation	Addition and subtraction
Mode	Operation mode, Preset data setting mode, Function setting mode
Reset	External reset terminal
Indication	LCD (with back-light)
Digits	6 digits
Memory Backup {medium}	Set values (Constantly hold), counts (hold/ non-hold switching) {E <sup>2</sup> ROM (alarm indication at approx. 800,000 data writings)}
Input signal	Count input, control signal input (reset, hold, bank selection)
Count Input	No-voltage input
Pulse signal input	A/B quadrature input, UP/ DOWN individual pulse input (Note 1)
Counting speed	100 kHz (Note 2)
Control signal input	"For connecting COM terminal to 12VDC or 24VDC" Conduction between each input terminal and GND terminal. "For connecting COM terminal to GND terminal" Conduction between each input terminal and 12VDC or 24VDC terminal.
power supply for sensor	12VDC ±10%, 60 mA
Preset output form	Compare, hold, one-shot (fixed at 100 ms)
Output method	Individual 5 points output, binary code output
Output time lag	5 ms or less (in normal output)/ 60ms or less (in binary output)
Communication	RS-232C
Proof voltage	Between case and AC line: 1500 VAC, 1 minute Between case and signal earth: 500 VAC, 1 minute
Insulation resistance	Between case and AC line: 500 VDC, 50MΩ or more
Ambient temperature	0°C to + 50°C (No freezing)
Ambient humidity	35% to 85%RH (no dew condensation)
Noise resistance	Square wave noise by noise simulator (pulse width: 1 μs) Between power terminals: ±2000V, input line: ±600V
Vibration proof	Durable to 10 Hz to 55 Hz and amplitude of 0.75 mm in X, Y and Z directions for 2 hours each.
Impact resistance	Durable to 10 G in X, Y and Z directions for three times each.
Weight	Approx. 350 g

	CEU5*-* (Without "B")	CEU5*B-*
Output signal	Preset output , cylinder stop output	Preset output , cylinder stop output , BCD output

	CEU5*-* (Without "P")	CEU5P*-*
Output transistor type	NPN open collector (Max. 30VDC, 50mA)	PNP open collector (Max. 30VDC, 50mA)

	CEU5**	CEU5**-D
Power voltage	100VAC to 240VAC (±10%)	24VDC (±10%)
Power consumption	20VA or less	10W or less

Note 1: Pulse signals can be counted by CEU5 should meet "Input waveform requirements" in the next page.

Note 2: Counting speed of 100 kHz is provided when "Input waveform requirements" are met. When signals are damped due to long wires, taking countermeasures such as reducing the speed is required.

### Input waveform requirements

#### [A/B quadrature input]

Two count channel input (A and B) in quadrature (90° nominal phase relationship).

A maximum of input waveform shall be 100 kHz, and the waveforms of A and B phases at this time are as below.

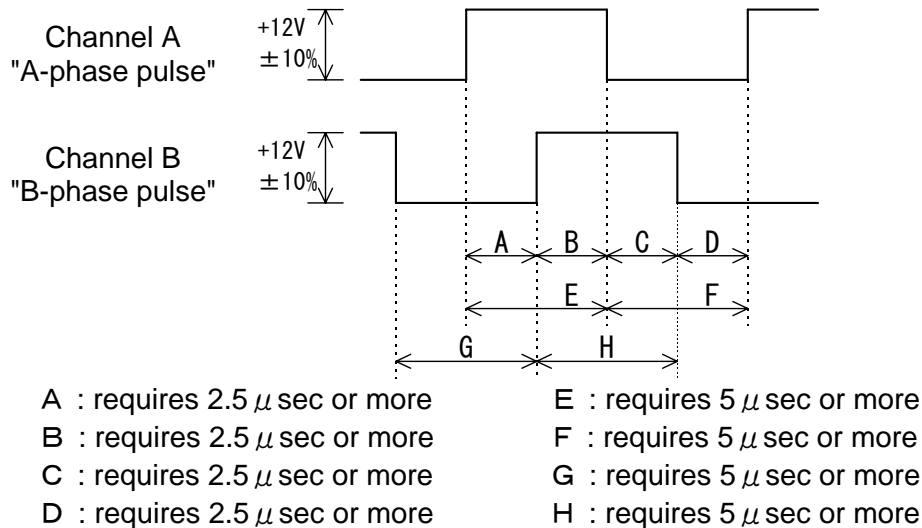

#### [UP/ DOWN individual pulse input]

"UP pulse" is a input to add the count, and "DOWN pulse" is a input to subtract the count.

A maximum of input waveform shall be 100 kHz, and the waveforms of UP and DOWN pulses are as below.

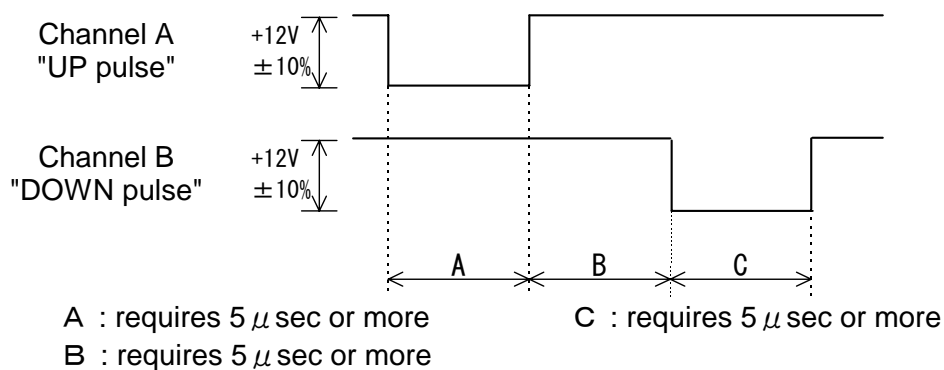

Not applicable to absolute type encoders.

### “When using encoders from other manufacturers”

When using encoders from other manufacturers, check if the encoders are within the specification range of CEU5 before use (Refer to the previous page and this page).

Performance test is given to SMC Monosashi-kun (Scale reading cylinders) and CEU5 using a 23 meter long exclusive extension cable. Wiring length depends on the specifications of the encoder and cable given by each manufacturer and it should be checked before use.

CEU5 has a power supply for encoder (12VDC, 60 mA). If an encoder requires a power other than 12VDC or large current consumption, use a separate power supply.

# Chapter 5: Description of Each Part

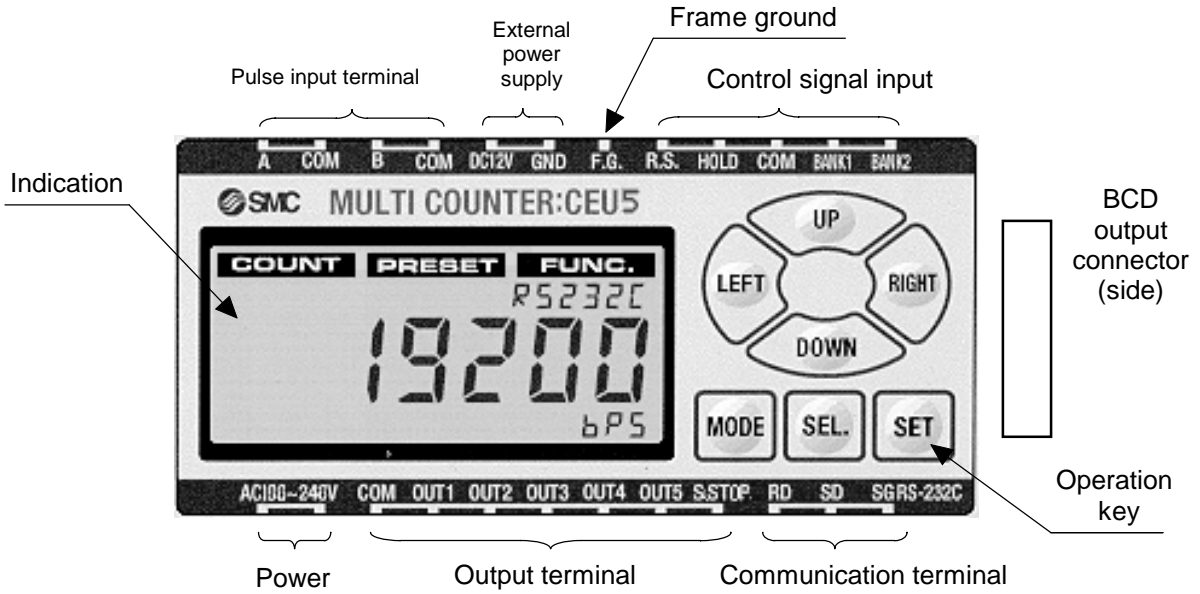

## [Indication part details]

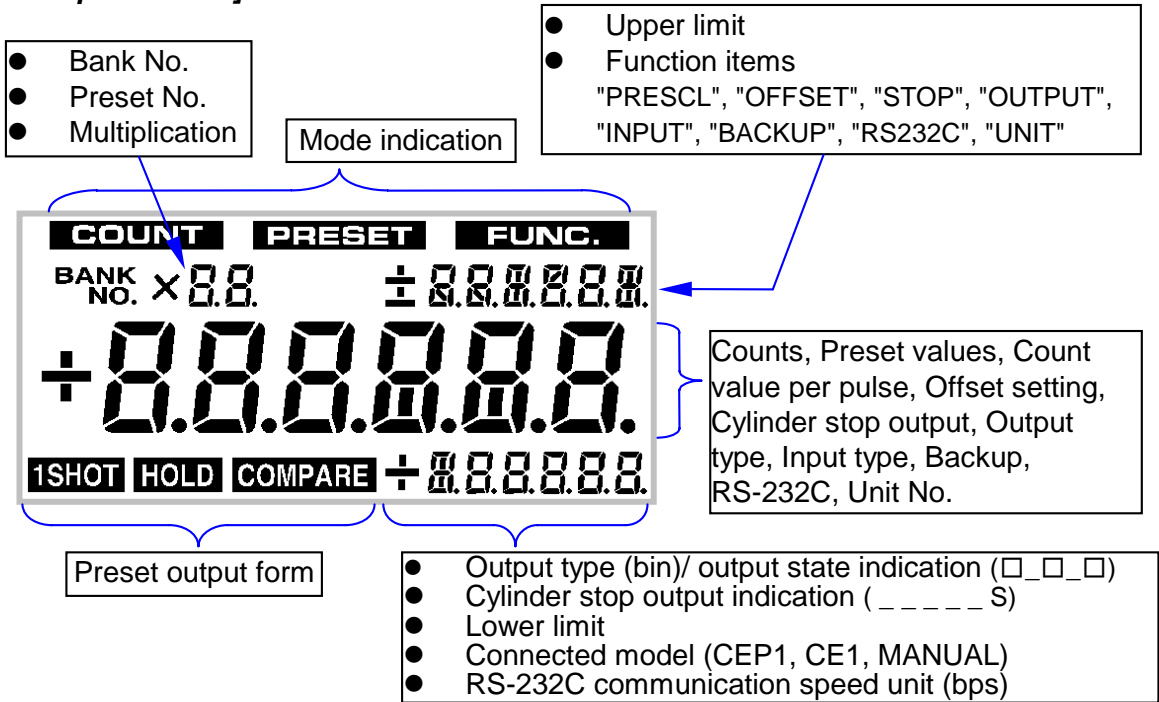

## Chapter 6: Wiring

### 6-1. Terminal block arrangement

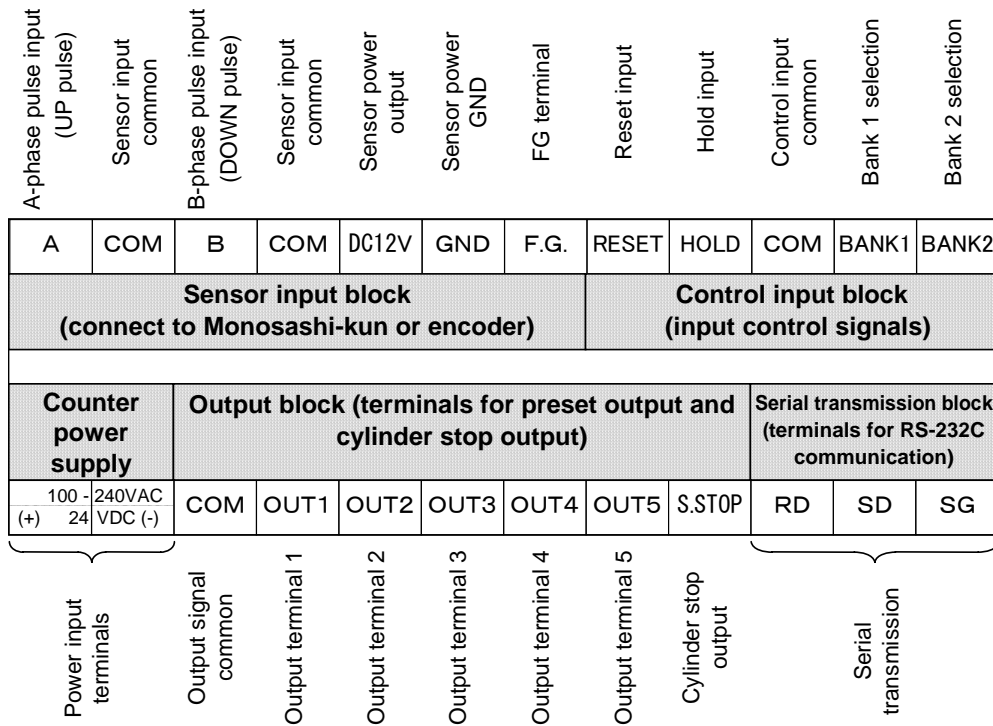

#### ⚠ Caution

The COM terminal of each block is insulated from COM terminals of other blocks.  
(However, COM terminal and GND terminal in sensor input block are connected inside).

### 6-2. Wiring of sensor input part

Change the wiring combination of white-A/blue-COM and yellow-B/brown-COM like white-B/blue-COM and yellow-A/brown-COM in pair to reverse the count direction.

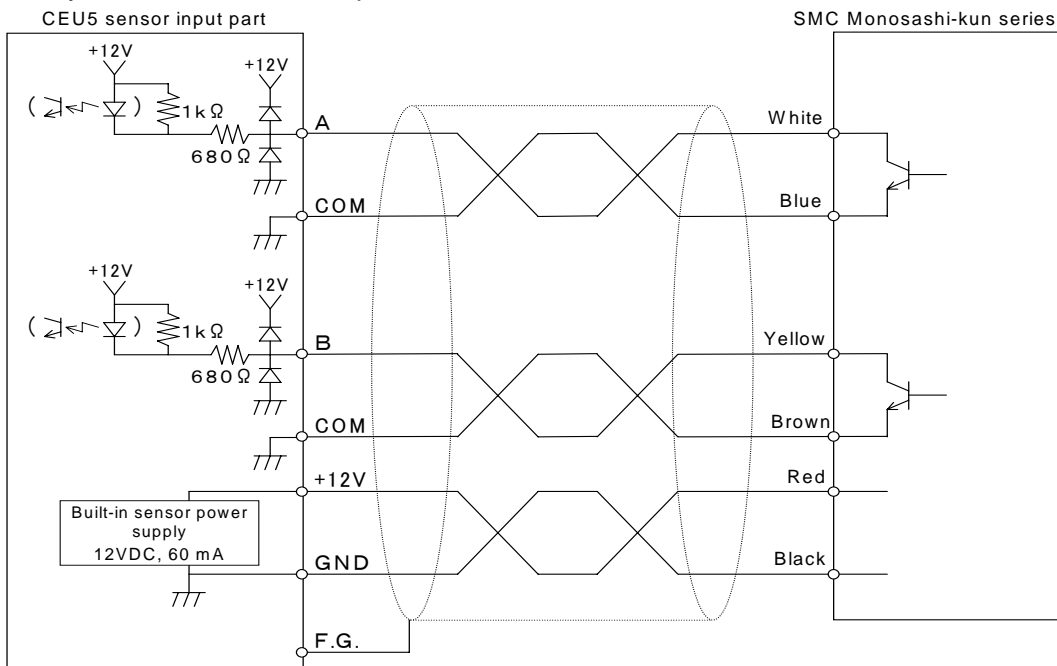

#### ⚠ Caution

Wire colors are for SMC Monosashi-kun series. For other encoders, check the wiring specified in encoder operation manual.

### 6-3. Wiring of control signal input part (reset, hold and bank selection)

Each control signal shall be inputted in a circuit using a transistor that allows current flow of 15 mA or more, or a circuit of contact output. Input time for reset signal shall be 10 ms or longer. Bank selection and hold are active only in signal inputting.

COM is common for each signal input as well as for NPN and PNP input types. Use a power of 24VDC or 12VDC and connect to DC- for PNP input and to DC+ for NPN input.

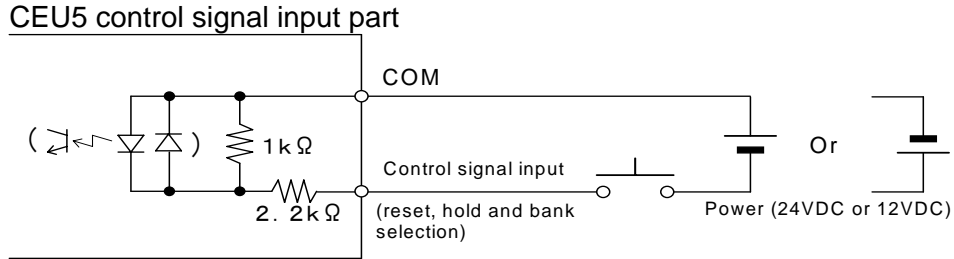

### 6-4. Wiring of output part (preset output and cylinder stop output)

The following shows the wiring for preset output (OUT 1 through 5) and cylinder stop output (S. STOP) with two output types: NPN and PNP.

Model	Wiring
CEU5 CEU5B CEU5-D CEU5B-D	<p>NPN transistor (open collector output)</p>
CEU5P CEU5PB CEU5P-D CEU5PB-D	<p>PNP transistor (open collector output)</p>

### 6-5. Wiring of RS-232C

Electric feature: complying with EIA RS-232C

Terminal block signal name

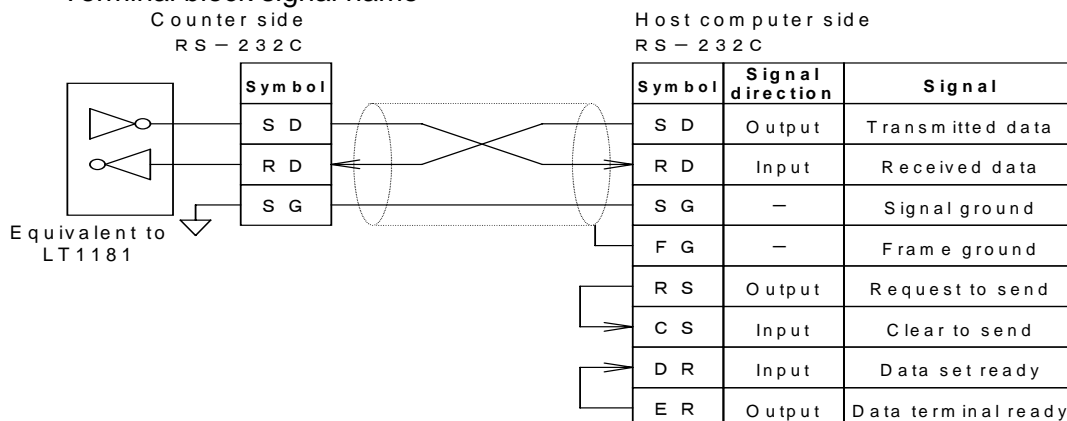

## 6-6. Noise countermeasures

Follow the instructions below to prevent malfunction due to noise.

- (1) Use SMC extension cable CE1-R\*\* for wiring of Monosashi-kun and CEU5.
- (2) Use a shielded cable of 5 meters or less for wiring of control input signals, output signals and serial transmissions.
- (3) Keep signal wires away from the power cables in wiring.
- (4) When cables may cause radiation noise, mount a ferrite core on a signal cable.
- (5) Use another stable power source for CEU5 power supply, separate from motor and solenoid valve for AC type.
- (6) Mount a noise filter for possible noise effects of power source.
- (7) Keep relays at least 10 cm away from CEU5 when they are installed.
- (8) Power supply voltage DC24V type of CU5\*\*D will conform to EMC directive (2004/108/EC) in combination with stroke reading cylinder (CE1 series) or high precision stroke reading cylinder (CEP1 series).

-

## Chapter 7: Setting and Counter Operation

### 7-1. Modes and setting items

CEU5 does not have DIP-switch and setting of each item is done by software. There are three basic modes (count, preset and function) and eight items can be set in the function mode.

#### 7-1-1. Mode types and functions

##### (1) Count mode

Count pulses coming from outside and display a value in the counter. At the same time, send out a signal to PLC/ PC if the count matches with the preset data. Output process is only done in this mode.

##### (2) Preset mode

Set preset data (preset value, upper limit and lower limit for the basis of output sending).

Note that preset data are 1 through 31, but 21 to 31 are only used for binary output.

##### (3) Function mode

Set eight items: pre-scale, offset, cylinder stop output, output type, input type, backup, RS-232C and unit No.

#### 7-1-2. Mode switching procedure

Mode can be switched by [MODE] key all the time. The initial mode (when turning ON the power) is count mode. Modes are switched each time [MODE] key is pressed in the order shown below. The mode at that time is displayed in LCD.

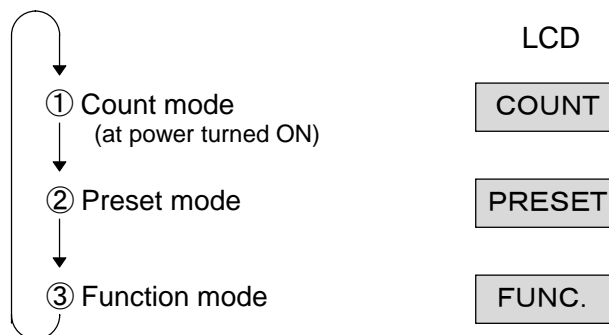

### **[Set first at purchasing]**

- For connecting the series CEP1  
The initial setting at shipment is ready for use.
- For connecting the series CE1, CE2 or ML2  
Set the counter to function mode and change the connecting model to CE1 in pre-scale setting. Refer to “Operation” in the following pages for details.
- For connecting encoders from other manufacturers  
Set the counter to function mode and change the connecting model to MANUAL in pre-scale setting. Next, set multiplication function and preset value. Refer to “Operation” in the following pages for details.



### 7-1-3. Setting of function mode

Eight items are set in function mode. Items can be switched by UP/ DOWN key during the items are flashing.

#### (1) Pre-scale

Display : **PRESCALE**

Meaning : Function to optionally set the unit per count

Setting : In model selection, select "CE1" for connecting the series CE1, CE2 or ML2 and "CEP1" for connecting the series CEP1 to complete pre-scale setting. For encoders from other manufacturers, select MANUAL and input multiplication and the unit per count by keys.

#### (2) Indication offset

Display : **OFFSET**

Meaning : Function to set the initial value displayed in reset inputting to an optional value (with +/- setting)

Setting : Input values by keys.

#### (3) Cylinder stop output

Display : **STOP**

Meaning : Cylinder stop output is a signal sent out from S. STOP terminal when pulse signals from Monosashi-kun (encoder) do not change for a certain period of time. This output signal provides better timing for reading preset output and outputs sent to PLC/ PC.

Setting : Input values by keys. Unit is 0.1 second.

#### (4) Output type

Display : **OUTPUT**

Meaning : Switch normal output (using bank function) and binary output (enabling classification of 31 points).

Setting : Select normal output "NORMAL" or binary output "BINARY".

#### (5) Input type

Display : **INPUT**

Meaning : Counter directions can be switched between A/B quadrature input and UP/ DOWN individual pulse input.

Setting : Select A/B quadrature input " $\pm$ 2PHASE" or individual pulse input " $\pm$ UPDOWN"

#### (6) Counts backup

Display : **BACKUP**

Meaning : Function to backup counts even when the counter power shut off

Setting : Select backup active "ON" or inactive "OFF".

#### (7) RS-232C communication speed

Display : **RS-232**

Meaning : Set communication speed of RS-232C.

Setting : Select a speed from 1200 bps, 2400 bps, 4800 bps, 9600 bps, or 19200 bps.

(8) Unit No.

Display: **U n 17**

Meaning : Set identification number of the counter, which is used for RS-232 communication.

Setting : Input values by keys.

(9) Digital filter

Display: **d - F 1 L 7**

Switch ON (Valid) and OFF (Invalid)

In case of ON, eliminate 10MHz or more of high frequency noise that interferes in input pulse. However, response of input pulse signal will be delayed for 0.9  $\mu$  S when filter is ON and for 0.5  $\mu$  S when it's OFF.

#### 7-1-4. Data setting range

Mode	Setting items	Setting range	Default value
Count	None	None	None
Preset	(1) Preset No.	1 to 31	1
	(2) Preset value	- 999999 to + 999999	+ 000000
	(3) Upper limit	- 999999 to + 999999	+ 000000
	(4) Lower limit	- 999999 to + 999999	- 000000
	(5) Preset output form	1SHOT/ HOLD/ COMPARE	1SHOT
Function	(1) Pre-scale • Connecting model	CEP1/ CE1/ MANUAL	CEP1
	• Multiplication	× 1, × 2, × 4	× 4
	• Count value per pulse	0.00001 to 999999	0.01
	• Decimal point position	*****. to *. *****	****. **
	(2) Offset value	- 999999 to + 999999 (Decimal point depends on the pre-scale.)	+ 000000
	(3) Cylinder stop output value	00.1 to 99.9 sec (When "0.00" is [SET], it will be "00.1".)	00.1
	(4) Output type	NORMAL/ BINARY	NORMAL
	(5) Input type	2PHASE/ UPDOWN	2PHASE
	(6) Backup	OFF/ ON	OFF
	(7) RS-232C	1200/ 2400/ 4800/ 9600/ 19200	9600
(8) Unit No.	00 to 99	00	
(9) Digital filter	OFF, ON	OFF	

#### Caution

**When default values are set, preset data will be set to zero (0). Take ample care for 1-shot output at turning ON the power.**

7-2. Setting

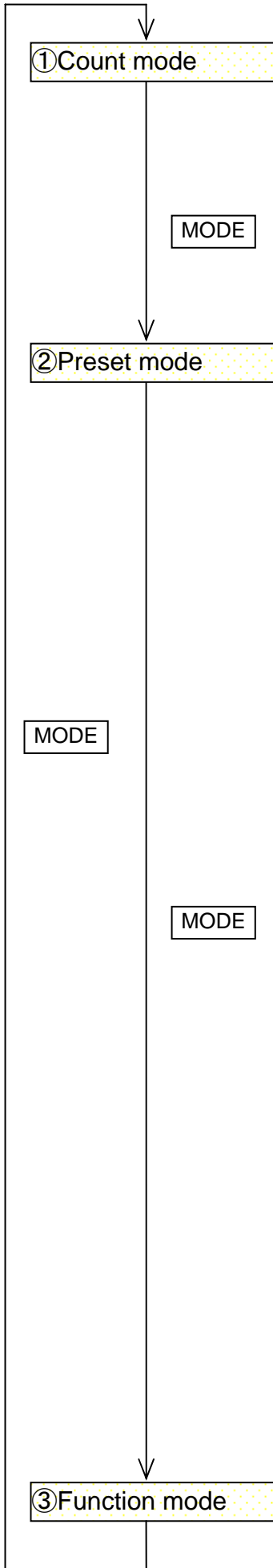

《Indication in normal output》

Indicate the current output bank

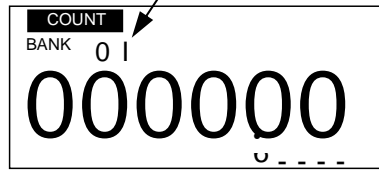

Indicate output condition of each OUT terminal.

《Indication in binary output》

Indicate only when incoming pulses matched with the preset data.

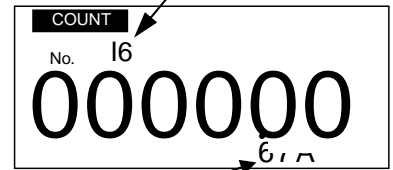

Indication when binary output is selected.

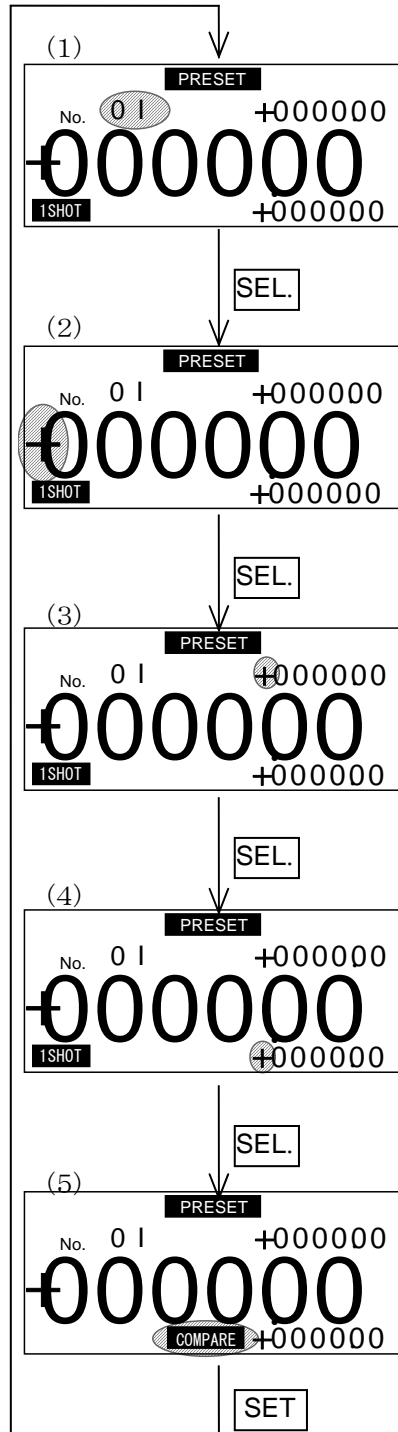

- SET key : Store indicated data in memory, in any condition of (1) to (5), and move onto (1).
- SEL key : Move onto the next item. Does not write data in memory.
- MODE key: Move onto the next mode in any condition. Does not write data in memory.

《Preset No. selection》

- Select preset No. from 1 through 31 by UP/ DOWN key.
- Move onto the next item by SEL. key.

《Preset value setting》

- Move digits by LEFT/ RIGHT key. Increase or decrease numerical values by UP/ DOWN key.
- Move on to the next item by SEL. key.

《Upper limit setting》

- Set numerical values by direction keys.
- When ± is selected, lower limit display disappears and ± can be set.
- Move onto the next item by SEL. key.

《Lower limit setting》

- Set numerical values by direction keys.
- When ± is selected in “Upper limit setting,” this item is not displayed.
- Move on to the next item by SEL. key.

《Output form setting》

- Switch output form to 1-SHOT, HOLD, COMPARE by UP/ DOWN key.
- Store the setting by SET key.
- With SEL. key, the cursor moves among items, but setting is not stored.

The following explains each setting in function mode.

Moving onto the next setting item by UP/ DOWN key during the items are flashing. The cursor moves by pressing SEL. key to change the setting for the item displayed.

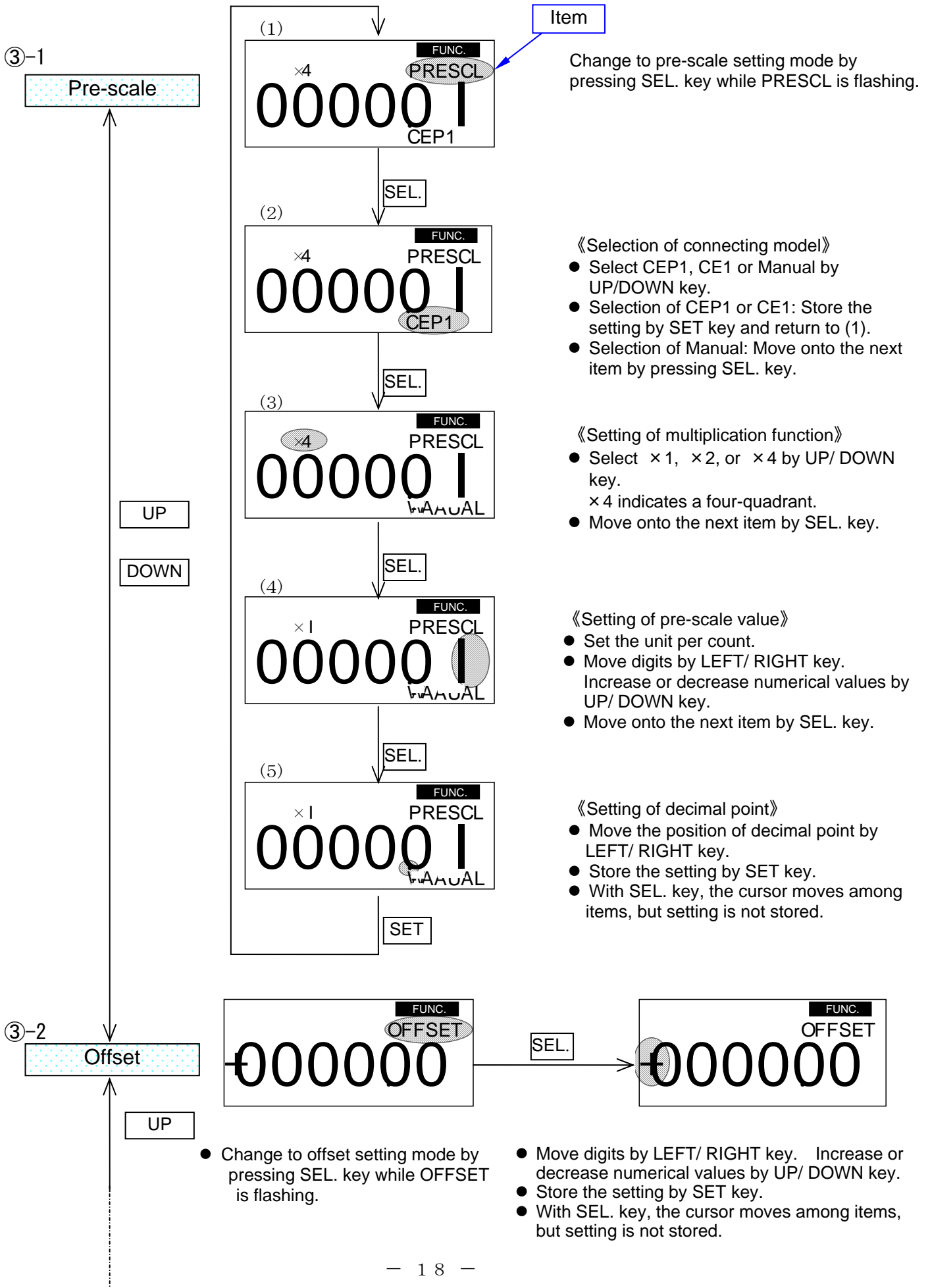

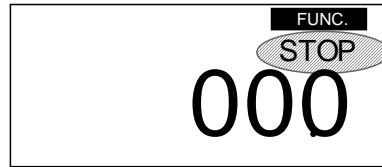
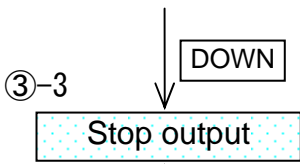

SEL.

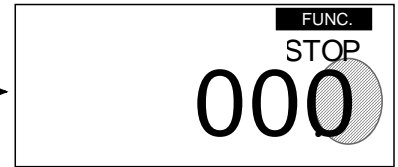

- Change to the mode of time setting for stop output sending by pressing SEL. key while STOP is flashing.

- Move digits by LEFT/ RIGHT key. Increase or decrease numerical values by UP/ DOWN key.
- Unit is 0.1 second.
- Store the setting by SET key.
- With SEL. key, the cursor moves among items, but setting is not stored.

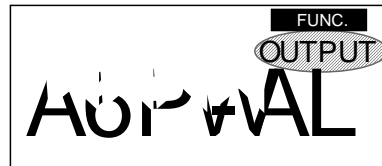
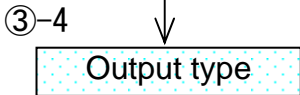

SEL.

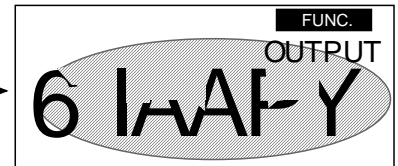

- Change to output type setting mode by pressing SEL. key while OUTPUT is flashing.

- Select normal or binary output by UP/ DOWN key.
- Store the setting by SET key.
- With SEL. key, the cursor moves among items, but setting is not stored.

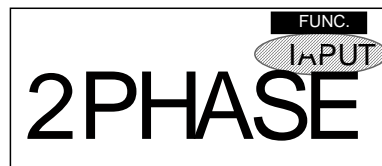
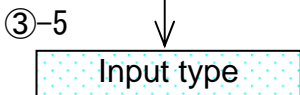

SEL.

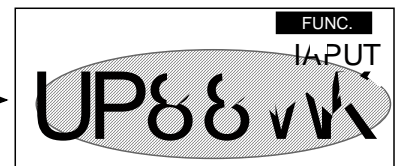

- Change to input type setting mode by pressing SEL. key while INPUT is flashing.

- Select A/B quadrature input (+/-2PHASE) or individual pulse input (+/-UP/ DOWN) by UP/ DOWN key. When polarity is changed, counter directions are reversed.  
2PHASE ⇔ UP/Down ⇔ -2PHASE ⇔ -UP/Down
- Store the setting by SET key.
- With SEL. key, the cursor moves among items, but setting is not stored.

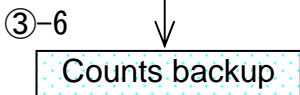
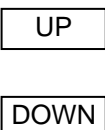

SEL.

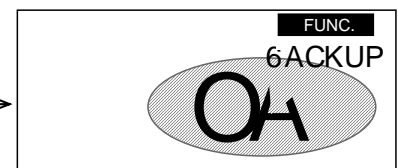

- Change to counts backup setting mode by pressing SEL. key while BACKUP is flashing.

- Select On or OFF by UP/ DOWN key.
- Store the setting by SET key.
- With SEL. key, the cursor moves among items, but setting is not stored.

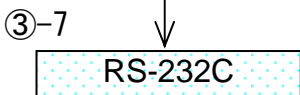

SEL.

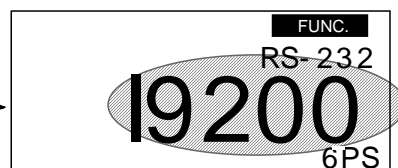

- Change to RS-232C communication speed setting mode by pressing SEL. key while RS-232 is flashing.

- Select communication speed among 1200, 2400, 4800, 9600 or 19200 by UP/ DOWN key.
- Store the setting by SET key.
- With SEL. key, the cursor moves among items, but setting is not stored.

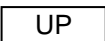

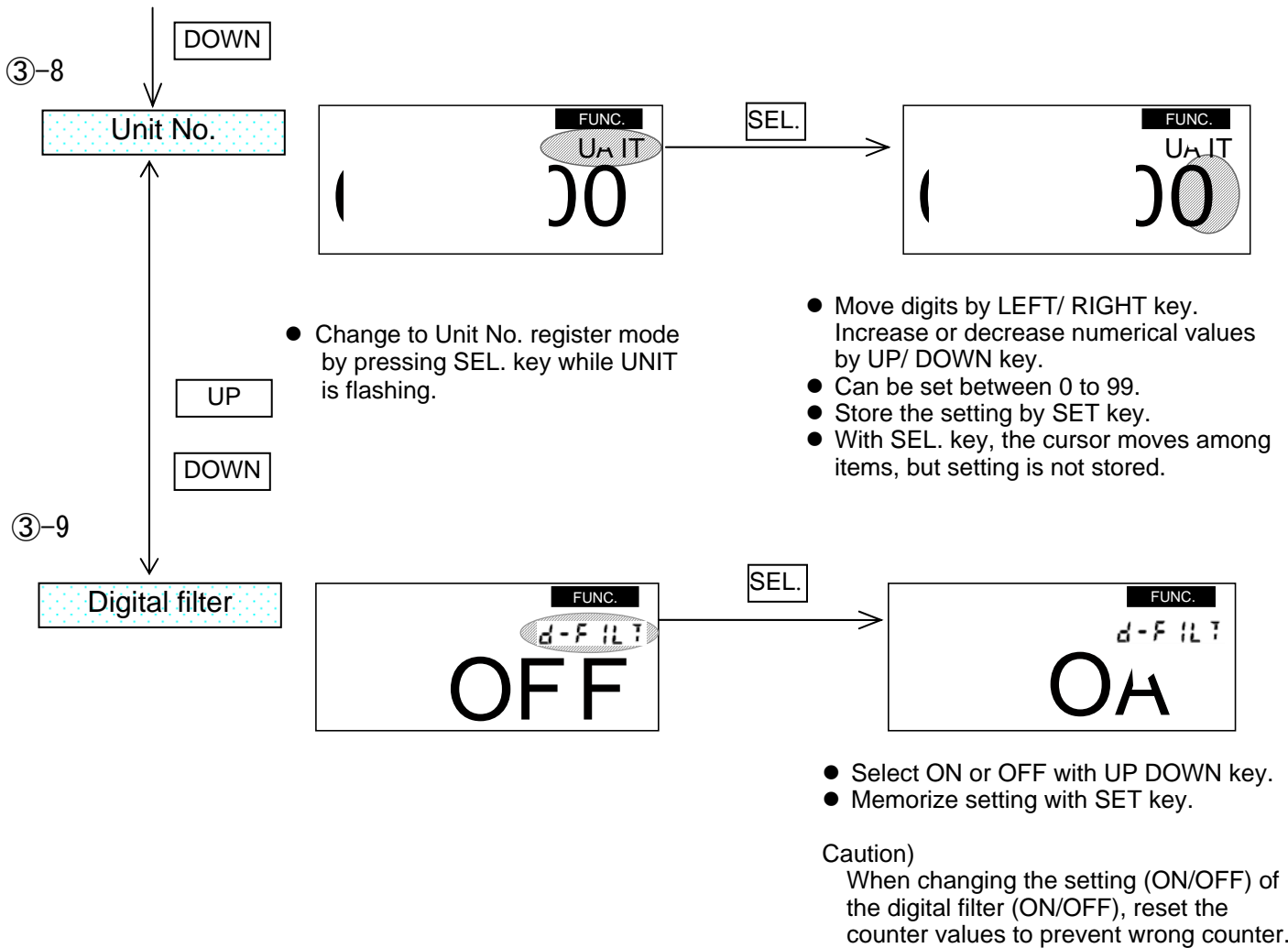

[Keys and functions]

Keys	Functions
MODE	Change modes. Move onto the next mode in any condition. Does not write data.
SEL.	Move the cursor onto the next item. Does not write data.
SET	Store indicated data at setting in memory.
RIGHT	Move the cursor to the right at setting numerical values.
LEFT	Move the cursor to the left at setting numerical values.
UP	Change the setting. Increase numerical values at setting.
DOWN	Change the setting. Decrease numerical values at setting.

- “Direction keys” in operation procedure indicate four keys: UP, DOWN, LEFT and RIGHT.

### 7-3. Counter operation

#### 7-3-1. Handling data range

Data range of the counter inside is between -7,999,999 to + 7,999,999. If a value in the counter is out of the range, it displays "FFFFFF" and stops counting (For over + 8,000,000, it displays "FFFFFF" and displays "FFFFFF" for below -8,000,000. "-FFFFFF" is displayed with the decimal point already set).

Outputs in counter mode are six digits between -999,999 to + 999,999. Display overflow is disregarded and lower six digits are displayed.

#### 7-3-2. Reset and hold input

##### [ Reset input ]

By using reset input from outside, count value can be reset as initial value. Initial value is determined by "Indication Offset". If the value of "Indication Offset" is 0, it will be cleared as 0 by reset input.

##### [ Hold function (for RS-232C communication or BCD output) ]

The display on the counter is held during a hold signal is coming in. With RS-232C communication or BCD output, the data indicated is sent out. Even if reading process of the PLC is delayed, the count when the hold signal is inputted can be taken in.

The display is held, however, counting is continued inside. At this time, preset output is sent out according to the count inside with or without hold signal.

#### 7-3-3. Correspondence of banks and bank terminals at switching

In count mode, switching of banks 1 through 4 are done by bank input terminals.

Bank No.	Bank terminal 2	Bank terminal 1
1	OFF	OFF
2	OFF	ON
3	ON	OFF
4	ON	ON

#### 7-3-4. Correspondence of preset numbers and output terminals

##### [ For normal output ]

Preset numbers (1 to 20) are allocated to output terminals of 1 through 5 as in the table below according to the bank number.

Bank No.	Output terminals				
	1	2	3	4	5
1	1	2	3	4	5
2	6	7	8	9	10
3	11	12	13	14	15
4	16	17	18	19	20

**[ For binary output ]**

The table below shows correspondence of preset numbers (1 to 31) and output terminals (OUT 1 to 5) in binary output. A smaller preset number is outputted when outputs are overlapped. Output form is COMPARE output only and fixed.

(O: ON, x: OFF)

Preset No.	Output terminals				
	1	2	3	4	5
1	O	x	x	x	x
2	x	O	x	x	x
3	O	O	x	x	x
4	x	x	O	x	x
5	O	x	O	x	x
6	x	O	O	x	x
7	O	O	O	x	x
8	x	x	x	O	x
9	O	x	x	O	x
10	x	O	x	O	x
11	O	O	x	O	x
12	x	x	O	O	x
13	O	x	O	O	x
14	x	O	O	O	x
15	O	O	O	O	x
16	x	x	x	x	O

Preset No.	Output terminals				
	1	2	3	4	5
17	O	x	x	x	O
18	x	O	x	x	O
19	O	O	x	x	O
20	x	x	O	x	O
21	O	x	O	x	O
22	x	O	O	x	O
23	O	O	O	x	O
24	x	x	x	O	O
25	O	x	x	O	O
26	x	O	x	O	O
27	O	O	x	O	O
28	x	x	O	O	O
29	O	x	O	O	O
30	x	O	O	O	O
31	O	O	O	O	O

Preset data are represented by combinations of output signals from OUT 1 to 5. When incoming pulses do not match with any preset numbers, all the outputs (OUT 1 to 5) are turned OFF. Reading OK signal is cylinder stop output. Binary output is only active when a cylinder is at stop. Reading outputs by PLC/ PC shall be done only when cylinder stop output is ON. Preset values can be stored up to 31 points. However, No. 21 to 31 are only active in binary output and their preset output form is fixed at "COMPARE" mode.

7-3-5. Output

- (1) Output form can be set to preset data No. 1 through 31 (However, No. 21 to 31 are only active in binary output and their preset output form is "COMPARE" only).
- (2) In normal output, indication in LCD corresponding to "OUT 1 to 5" changes from "\_" to "□" in preset output.
- (3) With upper or lower limit, if the preset data including lower limit (point A in the next page) or upper limit (point B in the next page) exceeds -999999 or + 999999, point A or B will be compulsorily corrected to the range of -999999 to + 999999.
- (4) Refer to "Output timing chart" in the following page for time of output delay.

 **Caution**

**With preset data set to zero, take ample care for preset output at turning ON the power.**



7-3-6. Preset output forms list

**[ COMPARE ]**: "COMPARE" indicated in LCD.

Without allowance	With allowance
<p>When a count matches with the preset value, output is ON. When they are different, output is OFF.</p>	<p>When a count is within the range of the preset value + allowance, output is ON. When a count is out of the setting range again, output is turned OFF.</p>

**[ 1-SHOT ]**: "1SHOT" indicated in LCD.

Without allowance	With allowance
<p>Output is ON for 100ms when a count crossed the preset value.</p>	<p>Output is ON for 100ms when a count crossed the preset value + allowance.</p>

**[ HOLD ]**: "HOLD" indicated in LCD.

Without allowance	With allowance
<p>Output is ON when a count crossed the preset value and the ON state is maintained until output is released. Releasing output is done either in power shut down, reset signal input, set value change or RS-232C command.</p>	<p>Output is ON when a count crossed the preset value and the ON state is maintained even when a count becomes out of the setting range. Releasing output is done either in power shut down, reset signal input, set value change or RS-232C command.</p>

7-3-7. Output timing chart

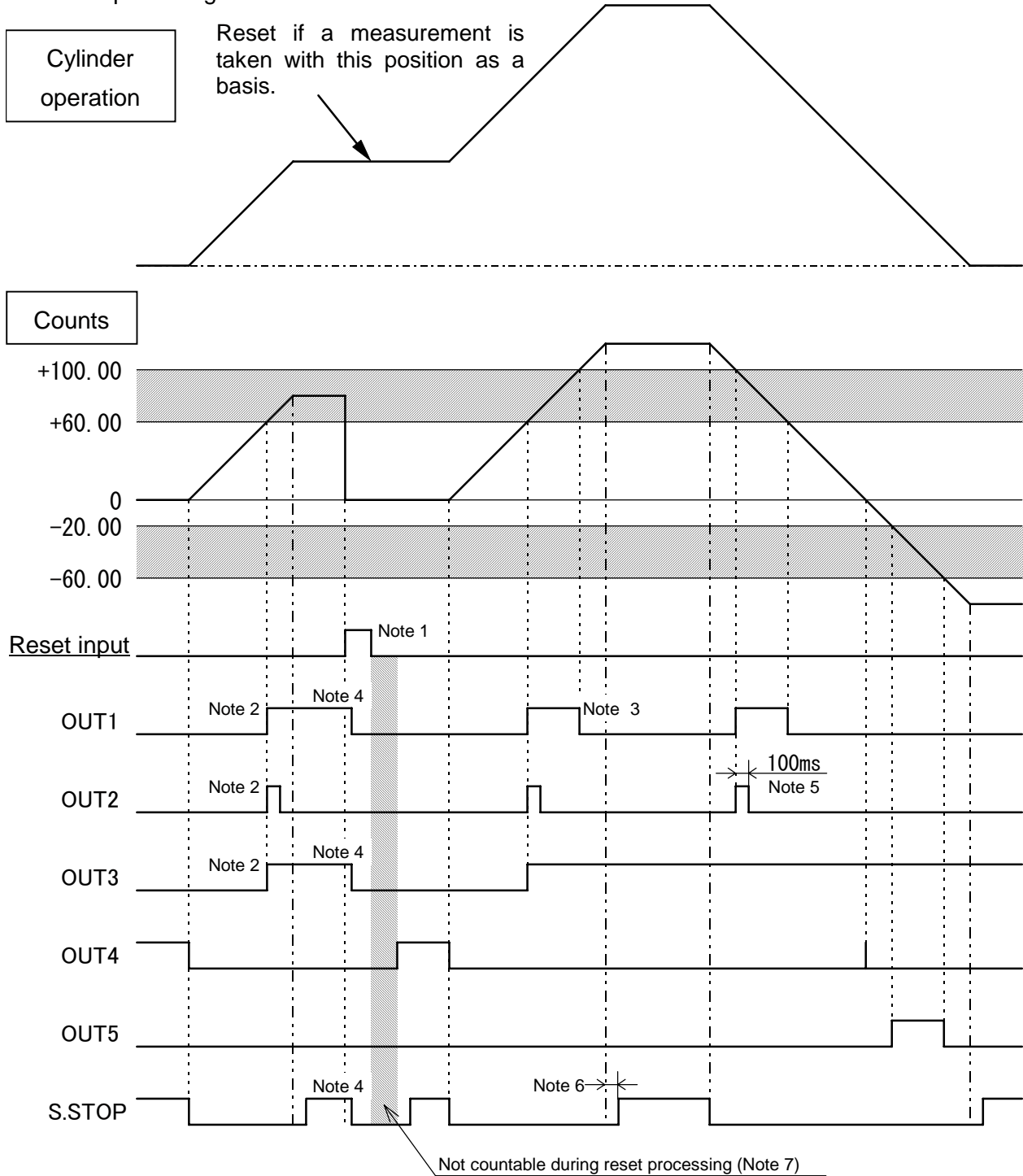

The above chart is an example when the settings of No. 1 through 5 are as in the table below (With normal output and bank 1 selection).

	No. 1	No. 2	No. 3	No. 4	No. 5
<b>Preset value</b>	+ 0060.00	+ 0060.00	+ 0060.00	+ 0000.00	- 0060.00
<b>Allowance (upper limit)</b>	+ 0040.00	+ 0040.00	+ 0040.00	+ 0000.00	+ 0040.00
<b>Allowance (lower limit)</b>	+ 0000.00	+ 0000.00	+ 0000.00	+ 0000.00	+ 0000.00
<b>Output form</b>	COMPARE	1-SHOT	HOLD	COMPARE	COMPARE

Note 1: Reset shall be done when the cylinder is at stop.

Note 2: ON delay time of preset output is 5 ms or less (in normal output and all output forms).

Note 3: OFF delay time of preset output OFF is 5 ms or less (in normal output and COMPARE output form only).

Note 4: OFF delay time at reset input is approximately 30 ms.

Note 5: 1-SHOT output is fixed at 100 ms.

Note 6: Waiting time for cylinder stop output ON can be set in the unit of 0.1 second in the item of STOP in function mode.

Note 7: Reset processing takes approximately 300 ms from reset input. Counting after reset shall be done after 350 ms or more has passed since the reset input. Input of reset signal from

PLC/ PC shall be between 10 ms and 100 ms. For longer input time, processing takes approximately 150 ms from startup of reset signal and it increases total reset processing time. That is, the shortest reset processing time takes 300 ms and it will be longer for longer reset signal input time.

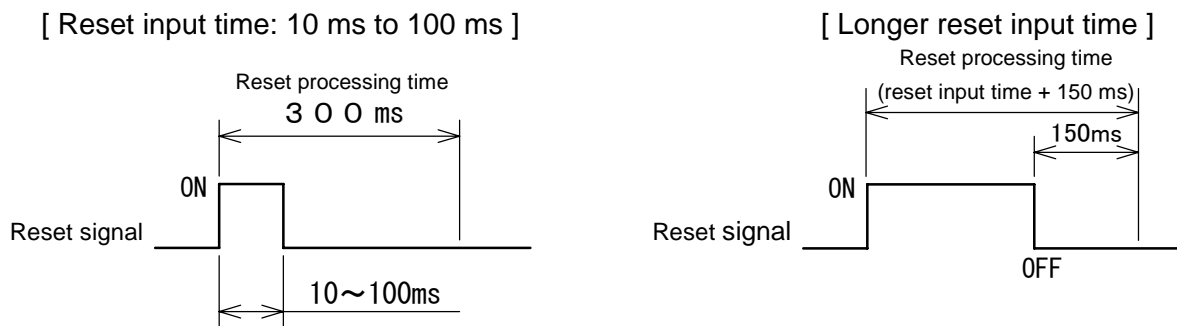

Note 8: Reset in RS-232C communication

When a reset command is received, a response is sent out from CEU5. CEU5 is ready for

counting in two seconds after sending the response. Operation to start counting after reset shall be done in two seconds or more after receiving the response.

Note 9: Power ON reset (at turning ON the power)

It takes approximately 1 second for the DC power to stabilize from turning ON. Then trouble check processing such as memory check is done and CEU5 is ready for counting in approximately 2.5 seconds from turning ON the power. Operation to start counting shall be done in three seconds or more after turning ON the power.

Note 10: Delay of binary output

Binary output is delayed for 30 ms or less. Reading of binary output shall be done only when cylinder stop output is ON.

### About "Cylinder stop output"

There are cases where cylinder stop output is output when cylinder stops temporarily due to knocking and cylinder operates at extremely low speed. In such cases, provide longer time to output.

### Caution

**When utilizing cylinder stop output for safety related parts, be sure to use it with other sensor output.**

### 7-4. Memory (E<sup>2</sup>ROM)

(1) The following data are stored in E<sup>2</sup>ROM.

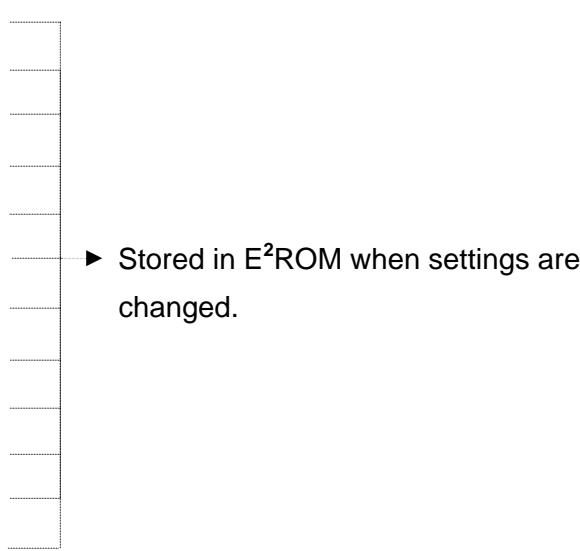
- Preset data
  - Upper and lower limits data
  - Output type
  - Pre-scale setting
  - Offset setting
  - Cylinder stop output setting
  - Output type setting
  - Input type setting
  - Backup setting
  - RS-232C setting
  - Unit No. setting
  - Digital filter setting
  - Current counts: Only when back up setting is ON, current counter value is different from data written in E<sup>2</sup>ROM and power supply is OFF, the current value is written in E<sup>2</sup>ROM.
- 
- Stored in E<sup>2</sup>ROM when settings are changed.

(2) When storing in E<sup>2</sup>ROM is done approximately 800,000 times, the message "E2FUL" (life of E<sup>2</sup>ROM) is indicated in LCD. Consult the shop or SMC Corporation. The indication disappears by pressing any key and resumes its normal operation after that.

(3) Backup check is done at turning ON the power and the message "E2Err" is indicated in LCD if an error occurred.

## Chapter 8: RS-232C Communication Functions

### 8-1. Communication specifications

Standard	RS-232C
Line type	Half duplex
Transmission type	Asynchronous
Transmission speed	Select from 1200, 2400, 4800, 9600, or 19200bps
Letter code	ASCII
Parity	Even parity
Start bit	1 bit
Data length	7 bit
Stop bit	1 bit
Block check	Sum check

### 8-2. Communication format

#### (1) Command list

	Command	Meaning	Count mode	Setting mode
①	VR	Reading counts	○	×
②	DR	Reading preset data	◎	○
③	DW	Writing preset data	◎	○
④	PR	Reading pre-scale setting	×	○
⑤	PW	Writing pre-scale setting	×	○
⑥	FR	Reading indication offset setting	×	○
⑦	FW	Writing indication offset setting	×	○
⑧	SR	Reading cylinder stop output setting	×	○
⑨	SW	Writing cylinder stop output setting	×	○
⑩	OR	Reading output type setting	×	○
⑪	OW	Writing output type setting	×	○
⑫	IR	Reading input type setting	×	○
⑬	IW	Writing input type setting	×	○
⑭	BR	Reading count backup setting	×	○
⑮	BW	Writing count backup setting	×	○
⑯	RS	Reset input	○	×
⑰	HR	Hold output release	○	×
⑱	TS	Test transmission	○	○
⑲	EE	Command error (response)	—	—

With ◎, command is accepted only when cylinder stop signal is sent out.



#### Caution

**Sequence shall have no safety problems for preset outputs changing when a setting is accepted.**

(2) Communication procedure and format

Initiative of the sequence is on the host computer side. The sequence always starts with the host computer side and the counter responds to it. The host computer side has the initial transmission right, and the counter always give a response back to the host computer when a command is transmitted from the host computer to the counter. However, the counter does not respond when counter unit No. specified is different or when parity error or check sum error occurs.

Command Block

#	Unit No.	Command code	Command data	Check sum	CR
---	----------	--------------	--------------	-----------	----

Response Block

#	Unit No.	Command code	Response data	Status	Check sum	CR
---	----------	--------------	---------------	--------	-----------	----

When data out of the setting range is coming in at setting by communication, setting is not conducted, instead response block (EE command) containing error code is sent back. The values set in setting mode by communication are stored in E<sup>2</sup>ROM. Since E<sup>2</sup>ROM has the life of 1,000,000 times, avoid unintentional continuous storing of the set values. The values set in counter mode are not stored in E<sup>2</sup>ROM.

(3) Check sum procedure

Operation range : from # to the last letter of command data

Operation procedure : Add all ASCII code in operation range and take a lower 1 byte.

Add 30H to the 1 byte.

Example:

#	0	0	V	R
23H	30H	30H	56H	52H

$$23H + 30H + 30H + 56H + 52H = 12BH$$

Take 2B and add 30H to each part of the 1 byte. Check sums are 32H and 3BH.

Therefore, command block will be:

#	0	0	V	R	2	;	[CR]
23H	30H	30H	56H	52H	32H	3BH	0DH

Note: ASCII code and check sum data

Check sum data are not the letter data of the ASCII code, but correspondence will be as the table below.

Letter data	0···9	A	B	C	D	E	F
ASCII	30H···39H	41H	42H	43H	44H	45H	46H
Check sum	30H···39H	3AH	3BH	3CH	3DH	3EH	3FH

(4) Status details

Status is 1 byte data. Lower 4 bit are used and upper 4 bit are unused (reserved).

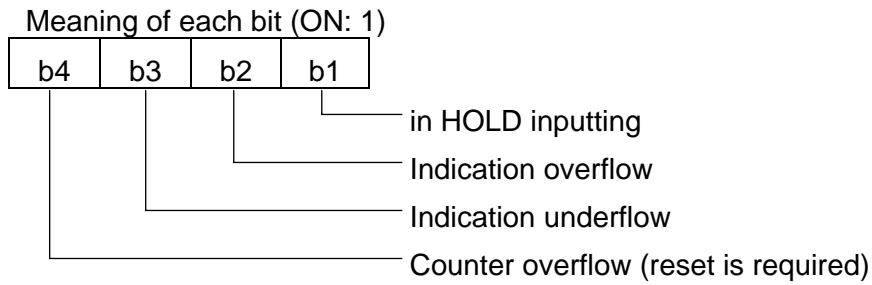

(5) Communication format details

① Reading counts VR

Command Block

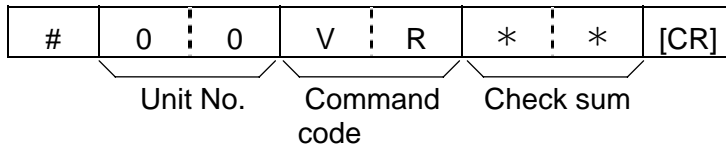

Response Block

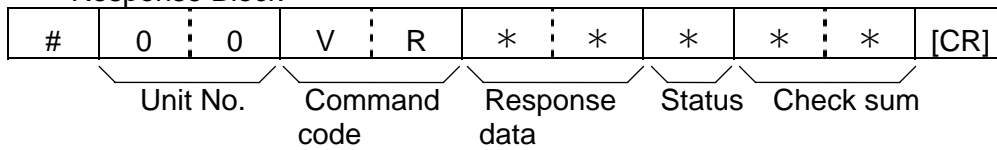

Response data details

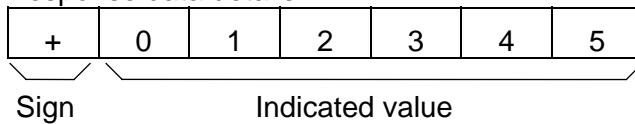

② Reading preset data

Command Block

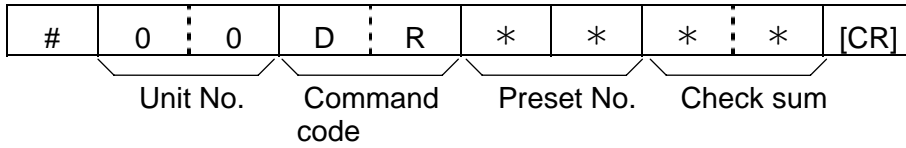

Response Block

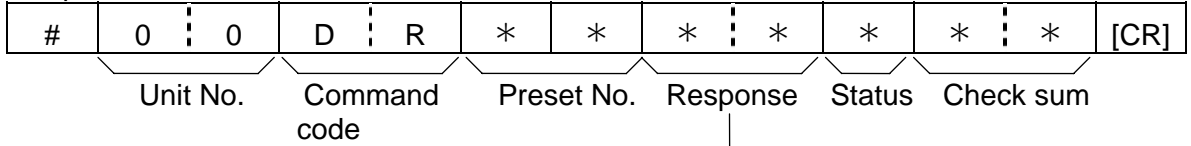

Response data details

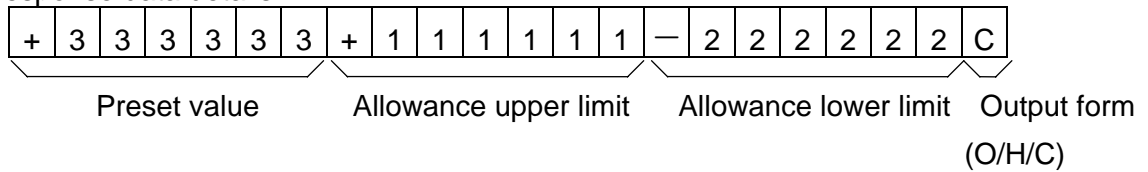

③ Writing preset data

Command Block

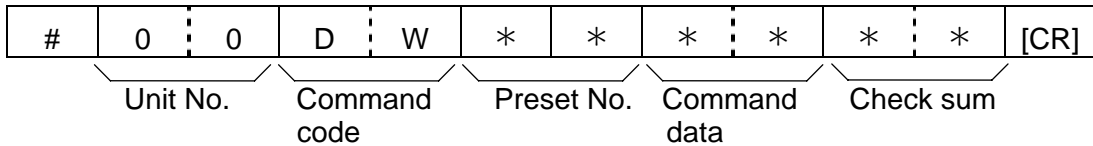

Command data details

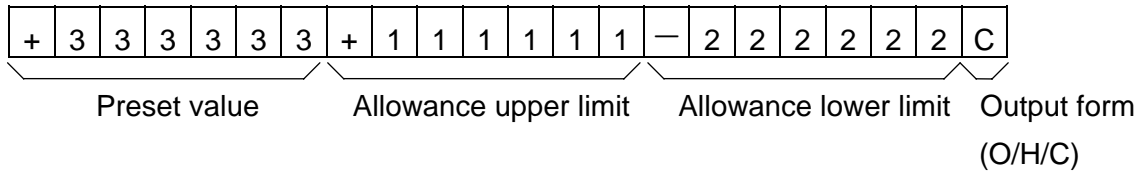

Response Block

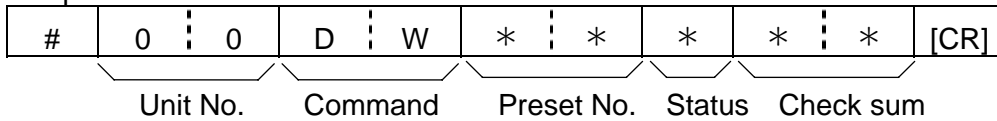

Note: For the value of zero (0), sign can be any of +, - or space.

- Output form    O: 1SHOT output  
                   H: HOLD output  
                   C: COMPARE output



④ Reading pre-scale setting

Command Block

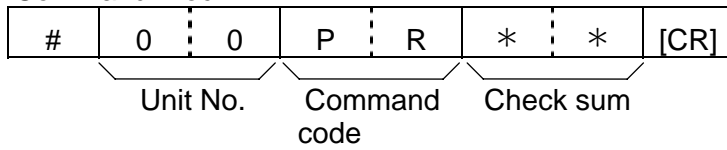

Response Block

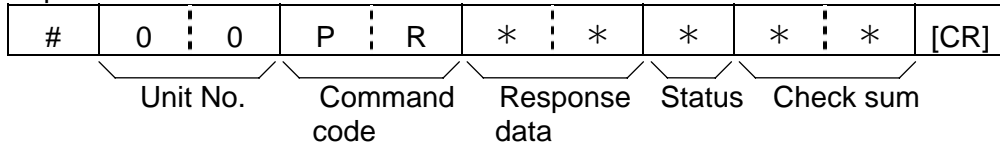

Response data details

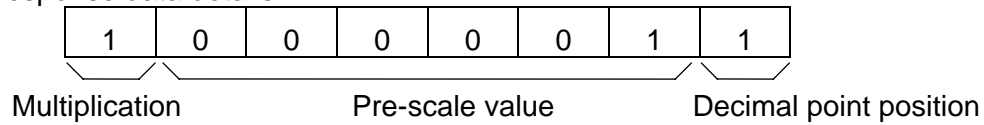

⑤ Writing pre-scale setting

Command Block

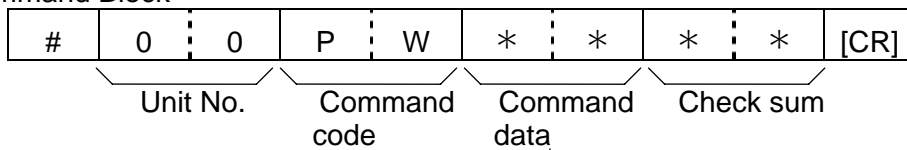

Command data details

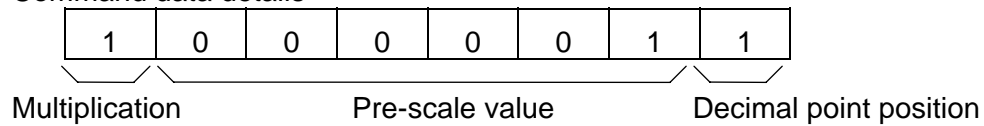

Response Block

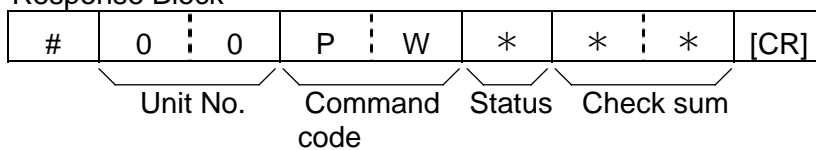

Note: For decimal point position, right end is 0 and in order of 1, 2, 3, 4, 5 towards left.

⑥ Reading indication offset setting

Command Block

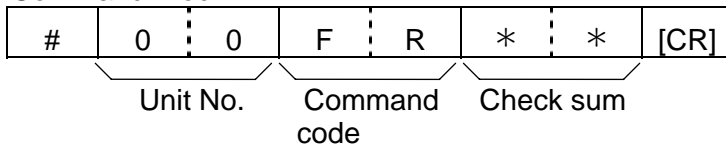

Response Block

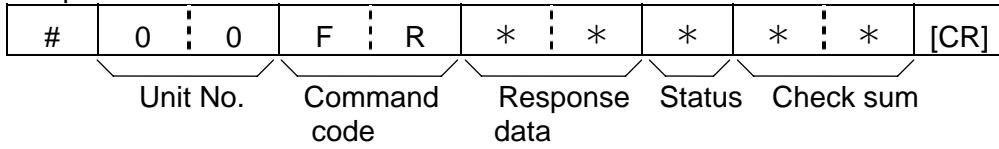

Response data details

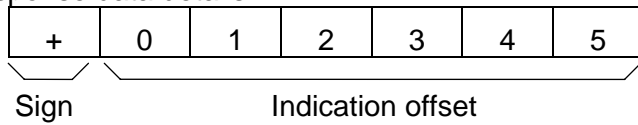

⑦ Writing indication offset setting

Command Block

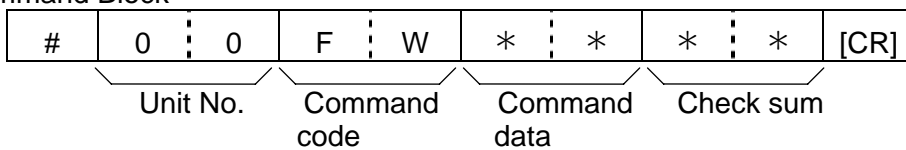

Command data details

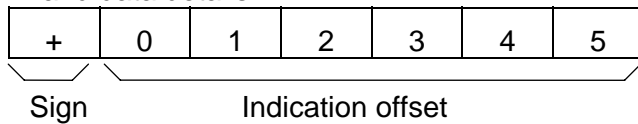

Response Block

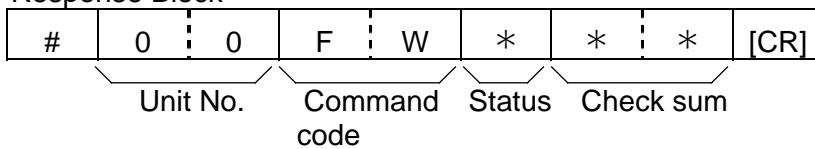

⑧ Reading cylinder stop output setting

Command Block

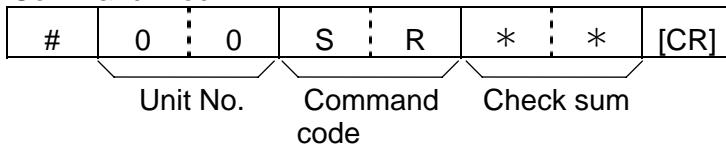

Response Block

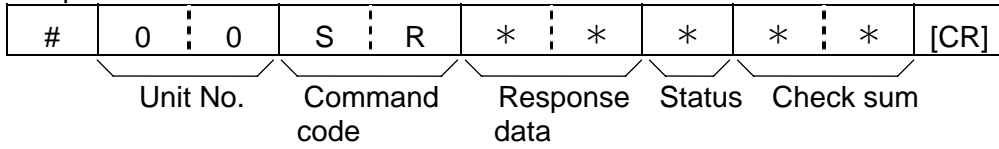

Response data details

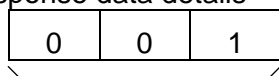

Stop output set time

Unit: 0.1 (s)

⑨ Writing cylinder stop output

Command Block

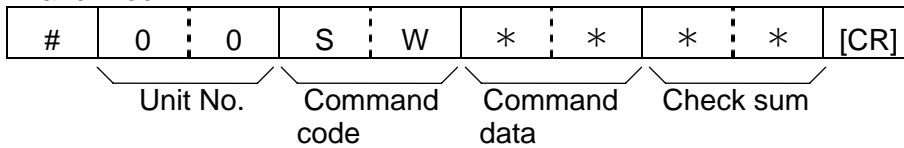

Command data details

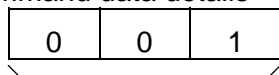

Stop output set time

Unit: 0.1 (s)

Response Block

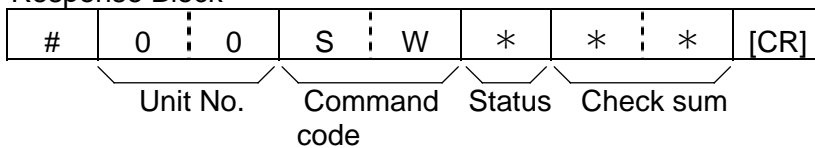

Note: Setting time for cylinder stop output is 1 (0.1 second) or more. For zero (0), error occurs.

⑩ Reading output type setting

Command Block

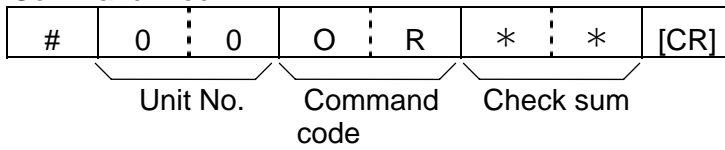

Response Block

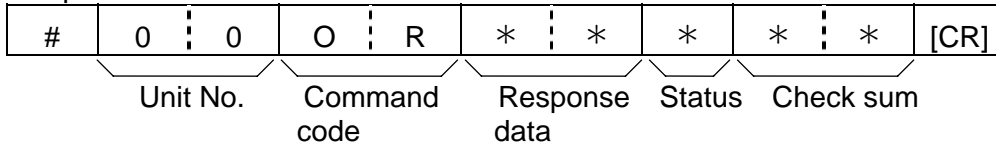

Response data details

0

0: Normal output

1: Binary output

⑪ Writing output type setting

Command Block

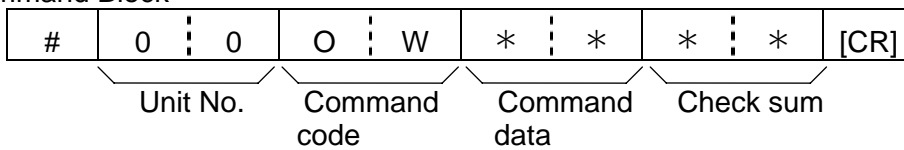

Command data details

0

0: Normal output

1: Binary output

Response Block

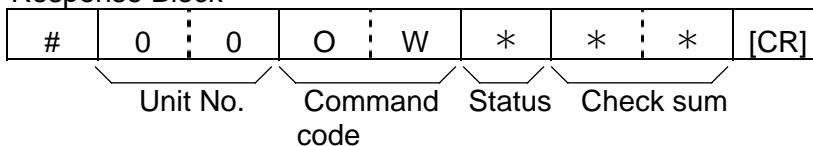

⑫ Reading input type setting

Command Block

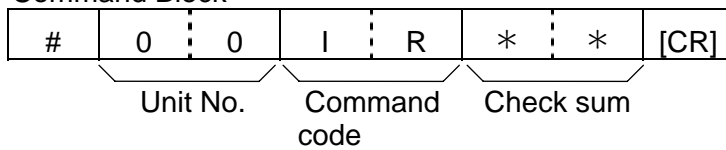

Response Block

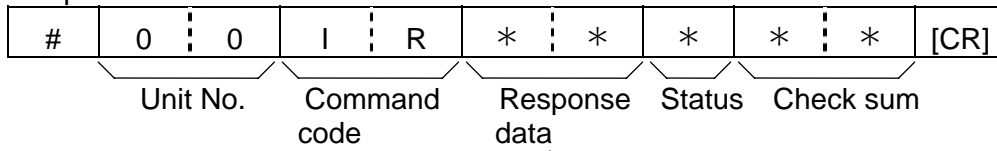

Response data details

0

0: Phase difference input of A and B phases

1: Individual input of UP/ DOWN

⑬ Writing input type setting

Command Block

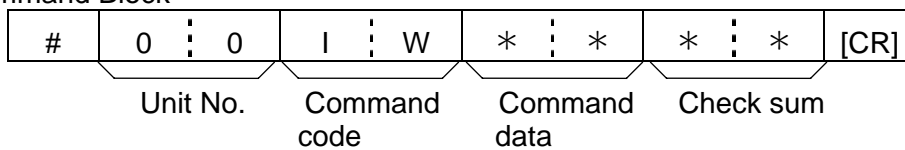

Command data details

0

0: Phase difference input of A and B phases

1: Individual input of UP/ DOWN

Response Block

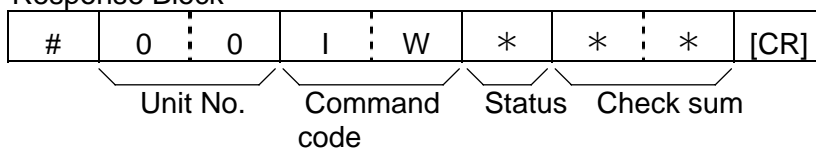

⑭ Reading count backup setting

Command Block

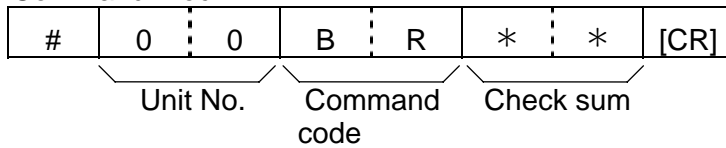

Response Block

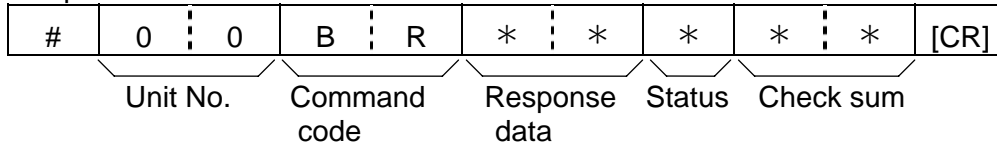

Response data details

0

0: Backup OFF

1: Backup ON

⑮ Writing count backup setting

Command Block

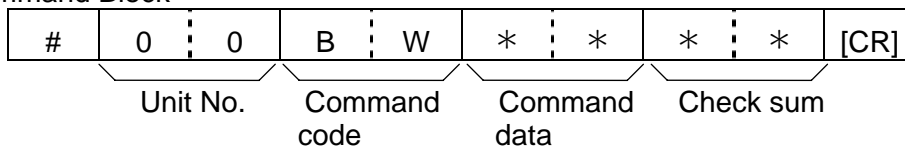

Command data details

0

0: Backup OFF

1: Backup ON

Response Block

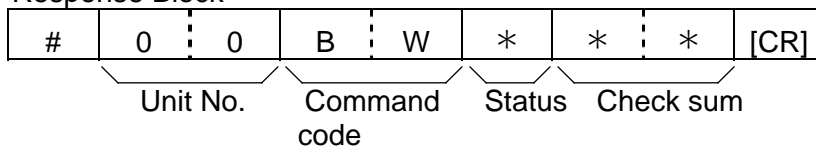

⑩ Reset input

Command Block

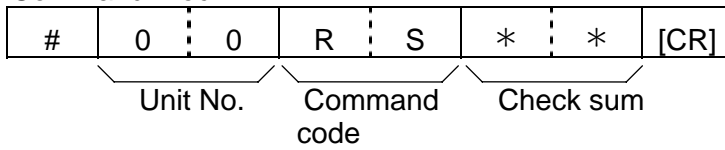

Response Block

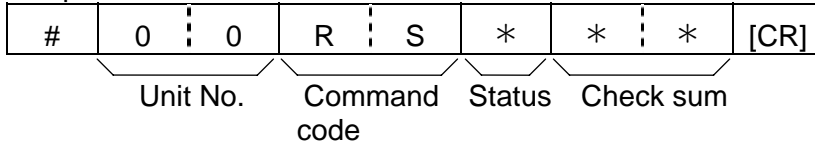

⑪ HOLD output release

Command Block

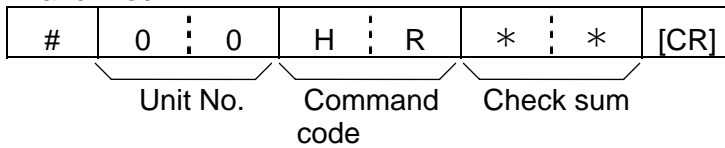

Response Block

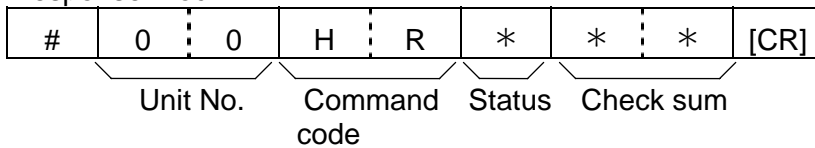

⑫ Test transmission

Command Block

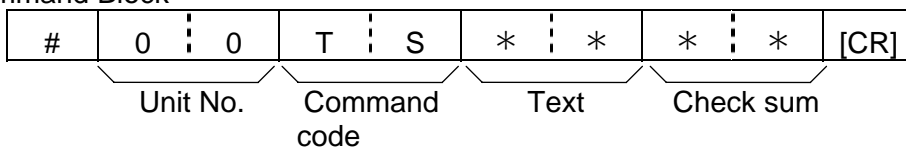

Response Block

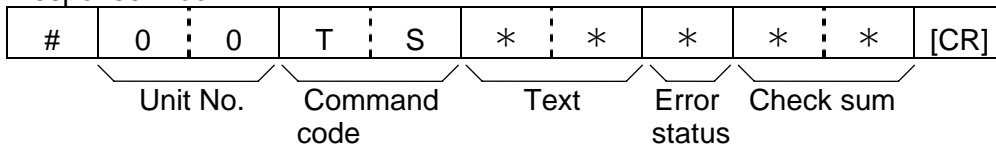

### Error status details

Code	Meaning
0	No troubles
1	Life of E <sup>2</sup> ROM (cannot write in): Consult the shop or SMC Corporation.
2	Parity error of E <sup>2</sup> ROM: Reset memory. Re-input all the data since these are erased after reset.

Note: Text is up to 10 byte. Error status indicates trouble on the counter side.

Troubles can be checked at turning ON the power. Error status is a text data of 1 byte.

### ⑱ Command error

#### Response Block

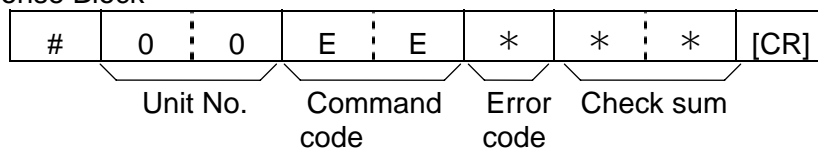

When there is an error in the command block that has been sent, the response block above is sent back to the host computer side. Error code is a text data of 2 byte.

Error Code	Meaning
0 1	Not executed due to count mode
0 2	Not executed due to setting mode
0 3	Set value differs from command format
0 4	No corresponding command
0 5	Not executed due to cylinder stop output OFF
0 6	(Unused)
0 7	(Unused)
0 8	(Unused)
0 9	(Unused)



## Chapter 9: BCD Output

CEU5\*B-\* type only has BCD output function.

- (1) BCD output connector : Half pitch D-sub connector  
DX10M-36S (made by Hirose Denki)
- (2) Applicable connector : DX30AM-36P (plug: made by Hirose Denki)  
DX30M-36-CV (cover: made by Hirose Denki)  
or commercial cable with connector on the market can be used, if it is compatible as above.

Note: When connectors (plug and cover) and cables (separately ordered) with the above mode number are wired, a crimping tool is necessary.

In addition, as applicable connectors and cables are available as ASS'Y, please contact MISUMI Corporation directly.

SHPT-H-36-L(length): One side of cable is loosened.

SHPT-HH-36-L(length): BCD connectors (male) are mounted on both sides of cable.

- (3) Pin allocation and output signals in detail

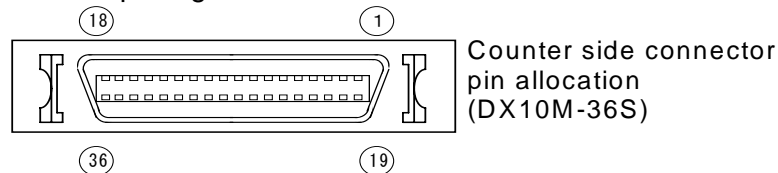

Pin No.	Signal	Meaning	Pin No.	Signal	Meaning
1	D0	Digit of $10^{-2}$ Bit0	19	D12	Digit of $10^1$ Bit0
2	D1	Digit of $10^{-2}$ Bit1	20	D13	Digit of $10^1$ Bit1
3	D2	Digit of $10^{-2}$ Bit2	21	D14	Digit of $10^1$ Bit2
4	D3	Digit of $10^{-2}$ Bit3	22	D15	Digit of $10^1$ Bit3
5	D4	Digit of $10^{-1}$ Bit0	23	D16	Digit of $10^2$ Bit0
6	D5	Digit of $10^{-1}$ Bit1	24	D17	Digit of $10^2$ Bit1
7	D6	Digit of $10^{-1}$ Bit2	25	D18	Digit of $10^2$ Bit2
8	D7	Digit of $10^{-1}$ Bit3	26	D19	Digit of $10^2$ Bit3
9	D8	Digit of $10^0$ Bit0	27	D20	Digit of $10^3$ Bit0
10	D9	Digit of $10^0$ Bit1	28	D21	Digit of $10^3$ Bit1
11	D10	Digit of $10^0$ Bit2	29	D22	Digit of $10^3$ Bit2
12	D11	Digit of $10^0$ Bit3	30	D23	Digit of $10^3$ Bit3
13	(+/-)	Sign	31	N.C.	Unused
14	DATA VALID	Reading OK signal	32	N.C.	Unused
15	N.C.	Unused	33	N.C.	Unused
16	COM	Signal ground	34	COM	Signal ground
17	N.C.	Unused	35	N.C.	Unused
18	COM	Signal ground	36	COM	Signal ground

The above output is displayed in the digit of  $10^{-2}$  to  $10^3$  when the counter is connected to SMC CEP1 series (decimal point setting is **\*\*\*. \*\***). When it's connected to CE1 series (point setting is **\*\*\*\*\*. \***), output is displayed in the digit of  $10^{-1}$  to  $10^4$  and the first place of decimal point is displayed in pin no., 1 to 4 (signal D0 to D3).

BCD output sending out is the same as a value shown in LCD. That is, output includes pre-scale and offset conditions ("FFFFFF" is outputted for counter IC overflow).

Polarity symbols (+/-) of Pin number 13 are assigned as shown below.

Low level (0): +/- High level (1): -

#### (4) Wiring example for BCD output part

The below shows a wiring example for NPN output type. For PNP output type, refer to the wiring shown in “6-4. Wiring of output part.”

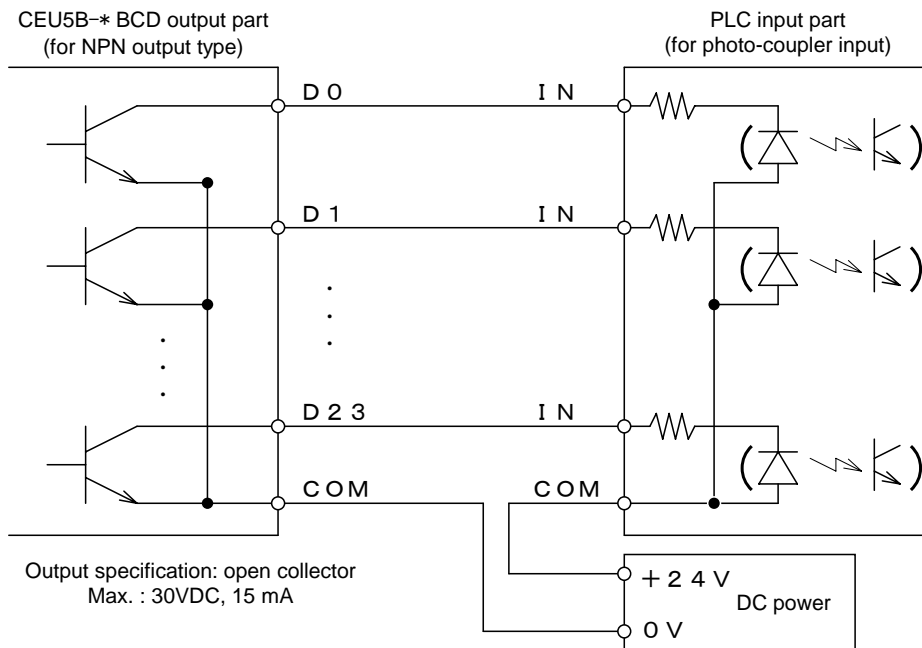

#### (5) Output timing

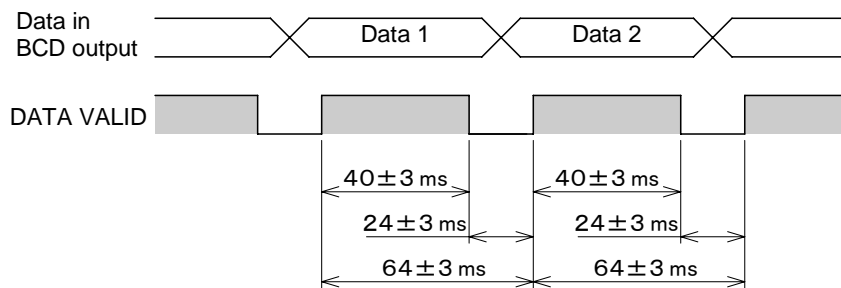

When readout enable signal is High (when output transistor is OFF), data will be valid. BCD output is continuously transmitted in the timing as shown above.

## Chapter 10: When the counter does not operate normally

### 10-1. Troubleshooting

Failure	Cause	Countermeasure	Page for reference
Does not count	Is the wiring of encoder input correct?	Refer to "Wiring" and correct the wiring.	11
	Is an encoder output signal matched with the counter input type?	Change the setting of A/B quadrature input and individual pulse input according to the encoder output signals.	9 & 19
	Is the counter in count mode?	Press [MODE] key to switch the current mode to count mode.	14
	Is HOLD input OFF?	Turn OFF HOLD input. Indication does not change while HOLD input is ON.	7
	Are the power voltage and current consumption of the encoder within the specification range of the power used?	Use a power suitable for the encoder specifications.	9
Miscounting	Is the pre-scale setting proper?	Set pre-scale according to the encoder type and measured object.	14 & 18
	Does the frequency of encoder output signals exceed the counting speed?	Reduce the speed and lower the frequency of encoder output signals.	9
	Is there a source of noise nearby?	Keep encoder signal wires and power wires (such as motor) away from each other at wiring.	13
Preset output is not sent out.	Is the wiring of preset output correct?	Refer to "Wiring" and correct the wiring.	12
	Are the values in preset setting proper?	Set proper setting values, allowance and output form.	23
	Is the output type setting correct?	Check the output type and select a proper type from normal output and binary output types.	5 & 19
	Is the +/- sign of the preset values proper?	Count may be minus depending on the encoder proceeding direction. In such a case, set preset values with minus sign.	17

<b>Failure</b>	<b>Cause</b>	<b>Countermeasure</b>	<b>Page for reference</b>
Cylinder stop output is not sent out.	Is the wiring of cylinder stop output correct?	Refer to "Wiring" and correct the wiring.	12
	Is the set time for output proper?	Set proper time taking timing on the reading side into consideration.	19
	Does the encoder detect the vibration of the equipment itself and keep sending signals even when the actuating part is stopped?	Reduce the vibration or use encoder with lower resolution.	9
Control signal input does not become active. [RESET] [HOLD] [BANK]	Is the wiring of control signal input correct?	Refer to "Wiring" and correct the wiring.	12
	Is each signal inputted in a proper time duration?	Reset input requires 10 ms or longer for pulse input. Hold signals for other inputs.	12
	Is the counter in count mode?	Press [MODE] key to switch the mode to count mode.	14
RS-232C communication cannot be done.	Is the wiring of RS-232C input/output correct?	Refer to "Wiring" and correct the wiring. Some devices do not operate only with three signal wires.	13
	Is the communication speed proper?	Set the communication speed to have the same speed for the counter and host computer	19
	Is the transmitted data matched?	Transmit data matched with the communication command.	27
	Are the unit numbers specified matched between the sending side and receiving side?	Match the unit numbers of the counter and transmitted data.	20
	Are the command and mode matched?	Some command are only active in count mode and others are only active in setting mode. Switch to a proper mode for the command.	27

10-2. Counter error indication

CEU5 checks troubles at turning ON the power. If an error occurs, take measures below.

Error indication	Meaning	Measures
ROMErr	Trouble occurred at reading a program from ROM.	<ul style="list-style-type: none"> <li>● Shut off the power and then turn it on again.</li> <li>● If normal operation cannot be resumed, consult the shop or SMC Corporation.</li> </ul>
RRmErr	Trouble occurred at testing RAM operation.	<ul style="list-style-type: none"> <li>● Shut off the power and then turn it on again.</li> <li>● If normal operation cannot be resumed, consult the shop or SMC Corporation.</li> </ul>
E2Err	Check sum trouble with E <sup>2</sup> ROM storing the set values.	<ul style="list-style-type: none"> <li>● Press any key to delete the memory and return to normal state.</li> <li>● Since the set values in the items in which an error was detected were deleted, make sure the settings and set values again.</li> </ul>
E2FUL	Alarm indication for the expired life of E <sup>2</sup> ROM. This is indicated when storing in E <sup>2</sup> ROM reached to about 800,000 times.	<ul style="list-style-type: none"> <li>● Press any key to return to normal operation.</li> <li>● The same indication appears after turning on the power next time.</li> <li>● Since replacement is required, consult the shop or SMC Corporation.</li> </ul>

Specifications are subject to change without prior notice.